

Feasibility Study for Renewable Energy Technologies in Alaska Offshore Waters



Photo from Levi Kilcher, National Renewable Energy Laboratory

U.S. Department of the Interior
Bureau of Ocean Energy Management
Alaska OCS Region, Anchorage, Alaska

BOEM
Bureau of Ocean Energy
Management

Feasibility Study for Renewable Energy Technologies in Alaska Offshore Waters

December 2023

Authors:

Rebecca Meadows
Aubryn Cooperman
Mariya Koleva
Caroline Draxl
Levi Kilcher
Elena Baca
Kerry Strout Grantham
Elise DeGeorge
Walter Musial
Nathan Wiltse
Omar Jose Guerra Fernandez

Prepared under Interagency Agreement Number M21PG00029

By

National Renewable Energy Laboratory
15013 Denver W Pkwy
Golden, CO 80401

U.S. Department of the Interior
Bureau of Ocean Energy Management
Alaska OCS Region, Anchorage, Alaska



DISCLAIMER

This study was funded, in part, by the U.S. Department of the Interior, Bureau of Ocean Energy Management (BOEM), Environmental Studies Program, Washington, DC, through Interagency Agreement Number M21PG00029 with the U.S. Department of Energy National Renewable Energy Laboratory (NREL). This report has been technically reviewed by BOEM, and it has been approved for publication. The views and conclusions contained in this document are those of the authors and should not be interpreted as representing the opinions or policies of BOEM, nor does mention of trade names or commercial products constitute endorsement or recommendation for use.

REPORT AVAILABILITY

To download a PDF file of this report, go to the U.S. Department of the Interior, Bureau of Ocean Energy Management Data and Information Systems webpage (<http://www.boem.gov/Environmental-Studies-EnvData/>), click on the link for the Environmental Studies Program Information System (ESPIS), and search on 2023-076. The report is also available at the National Technical Reports Library at <https://ntrl.ntis.gov/NTRL/>.

CITATION

Meadows R, Cooperman A, Koleva M, Draxl C, Kilcher L, Baca E, Strout Grantham K, DeGeorge E, Musial W, Wiltse N, Guerra Fernandez OJ. (National Renewable Energy Laboratory, Golden, CO). 2023. Feasibility study for renewable energy technologies in Alaska offshore waters. Anchorage (AK): U.S. Department of the Interior, Bureau of Ocean Energy Management, Alaska OCS Region. 131 p. Report No.: OCS Study BOEM 2023-076. Contract No.: M21PG00029.

ACKNOWLEDGMENTS

The authors would like to thank the many people who contributed to the content of this report, including the Contract Officer Representative, Sean Burril; the Environmental Studies Program Representatives, John Primo and Kristen Strellec; the Contracting Officer, Paula Barksdale; and the many BOEM and NREL reviewers. We would also like to recognize Sharon Randall, Regional Director of the Alaska OCS Region, and other BOEM Alaska staff for supporting renewable energy strategic planning in Alaska. We thank Marty Schwarz and Paul Denholm of NREL for sharing information from their current project assessing a renewable portfolio standard for the Alaska Railbelt grid. We thank Alaska Marine Power (AMP) for their review and feedback throughout the project. We were not able to address all of AMP's comments; any errors that arise as a consequence are our own. We acknowledge the contribution of relevant information from concurrent projects: co-author Mariya Koleva provided information from current efforts supporting the U.S. Department of Energy's Arctic Energy Office clean hydrogen road map for Alaska, and co-author Levi Kilcher shared information from current efforts on Cook Inlet tidal development from NREL and the Alaska Center for Energy and Power. We thank Billy Roberts and Donna Heimiller of NREL for their contributions to the content of the maps. Editing was provided by Amy Brice of NREL.

This work was authored by the National Renewable Energy Laboratory, operated by Alliance for Sustainable Energy, LLC, for the U.S. Department of Energy (DOE) under Contract No. DE-AC36-08GO28308. Funding provided by U.S. Department of Energy Office of Energy Efficiency and Renewable Energy Water Power Technologies Office. The views expressed in the article do not necessarily represent the views of the DOE or the U.S. Government. The U.S. Government retains and the

U.S. Department of the Interior
Bureau of Ocean Energy Management
Alaska OCS Region, Anchorage, Alaska



publisher, by accepting the article for publication, acknowledges that the U.S. Government retains a nonexclusive, paid-up, irrevocable, worldwide license to publish or reproduce the published form of this work, or allow others to do so, for U.S. Government purposes.

Executive Summary

This study was conducted by the National Renewable Energy Laboratory (NREL) for the Bureau of Ocean Energy Management (BOEM) under an interagency agreement with the U.S. Department of Energy. The study assesses the feasibility of ocean-based renewable energy sources that may be available to help Alaska decarbonize its energy supply, increase coastal resilience, and build energy security and independence. Throughout this report there are various timelines associated with modeling assumptions and policy scenarios that are being studied. The major elements of clean energy transition considered in this study—which include fixed and floating offshore wind energy, tidal energy, and carbon-neutral hydrogen fuels—are based on a 2035 timeline because some of these technology options are in an early stage of commercial development. Deployment in Alaska waters could increase logistical challenges during commercial development.

The study focuses on the portions of the Outer Continental Shelf (OCS) off the coast of Alaska and Alaska state waters that are south of the Bering Strait and east of the 169th meridian (**Figure ES-1**). BOEM's authority to regulate renewable energy projects extends from the state/federal boundary at 3 nautical miles from shore out to the 200-nautical-mile exclusive economic zone. This study intentionally includes state waters (outside BOEM's jurisdiction) to allow broader consideration of other marine energy technologies such as tidal energy and wave energy that often have their best resources closer to shore. A full evaluation of other renewable energy resources such as land-based wind and solar are beyond the scope of this report but should be considered as part of a more comprehensive statewide energy transition plan to decarbonize.

Ocean Energy Resource Assessment

Alaska's OCS holds vast renewable energy resource potential. We estimate that 3,800 gigawatts (GW) of *potential* wind, wave, and tidal energy resource capacity (**Figure ES-1**; Doubrawa et al. 2017, Kilcher et al. 2021) are in Alaska waters, which is more than 3 times the *current* total generation capacity of the United States in 2022 (1,200 GW) (U.S. Energy Information Administration [EIA] 2023b). However, due to many practical constraints, including long distances to demand (also called “load”), poor economic viability, and conflicts with other ocean users and wildlife, only a small fraction of this resource can practically be developed. Roughly 88% of this resource potential (3,350 GW) is from offshore wind energy, with wave energy and tidal energy at 9% (350 GW) and 2% (80 GW), respectively (subject to rounding). One of the biggest challenges is identifying the location and type of the best renewable resources that can economically support the energy needs for the population centers and industrial energy use sectors moving toward carbon neutrality. Most of these ocean energy resources are too far from where the electric power is needed, and long-distance transmission costs would be prohibitive. The highest-quality resources are the offshore wind and tidal resources closest to the Alaska Railbelt grid (connecting the populated areas from Fairbanks to Anchorage) with the highest energy density (e.g., high average wind speed, high average current speed, or high wave heights). These areas could potentially be developed before 2035–2040. Resources with limited or no access to the grid may possibly be viable if the electricity generated is used to produce carbon-neutral or “clean” hydrogen.¹ These hydrogen

¹ Clean hydrogen is defined as hydrogen produced with a carbon intensity equal to or less than 2 kg of carbon dioxide-equivalent produced at the site of production per kilogram of hydrogen produced. Source: (Regional clean ... [date unknown]).

scenarios are considered long-term options that could feasibly become part of the energy infrastructure by 2050.

Technical Power Potential of Alaska Marine Energy Resources

(in GW)

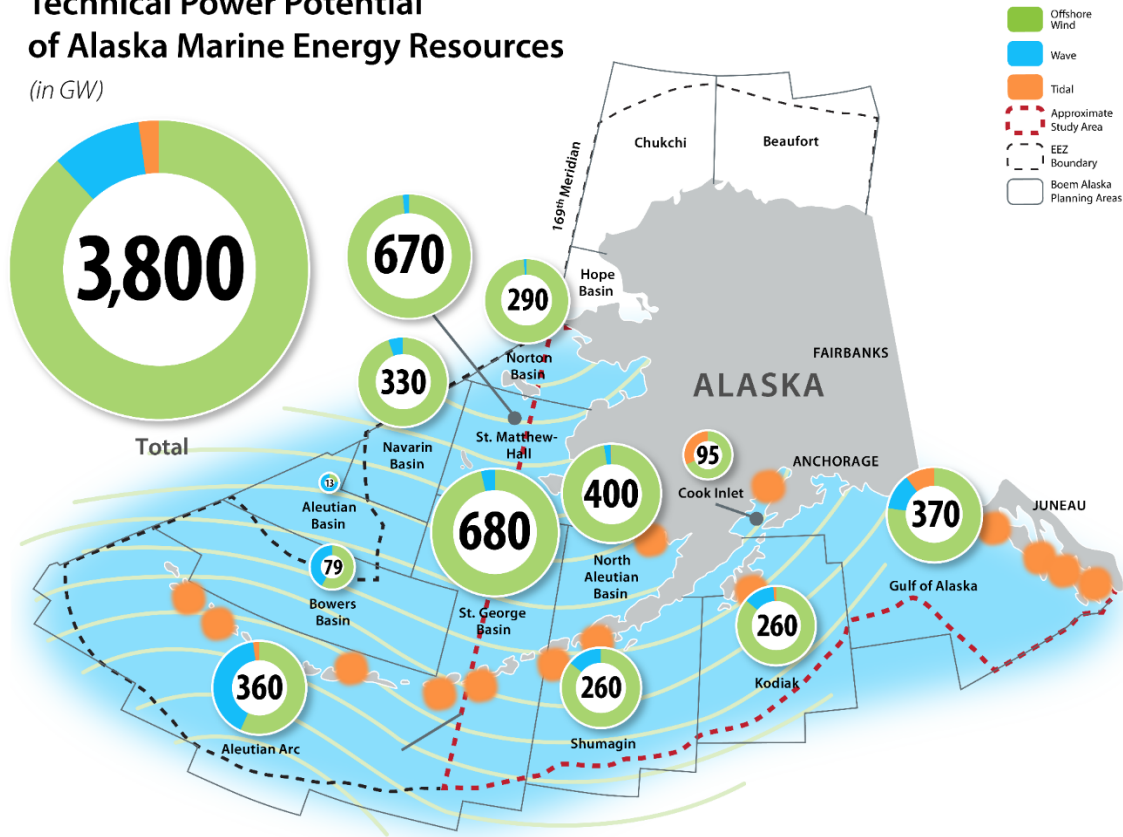

Figure ES-1. Offshore wind and marine energy resource totals by BOEM planning area

Data from Doubrava et al. (2017) and Kilcher et al. (2021), Illustration by NREL

Market Assessment

Alaska has more than 720,000 people dispersed over 360 communities, with nearly half residing in the communities of Anchorage, Fairbanks, and Juneau (State of Alaska 2022). In 2020, total energy consumption² in Alaska was ~640 trillion British thermal units, as shown in **Figure ES-2** (Lawrence Livermore National Laboratory 2023). Approximately 8.6% of this total energy can be attributed to

² Note that energy units are reported in different ways depending on the source. Residential electricity use is generally reported in units of kilowatt-hours (kWh) or 1,000 watts of usage over an hour. Electricity that is sold commercially is usually reported in megawatt-hours (MWh); 1,000 kWh is equal to 1 MWh. Similarly, bulk electricity that is reported statewide or in larger quantities is often given in gigawatt-hours (GWh); 1,000 MWh is equal to 1 GWh. Energy is also reported in British thermal units (BTU)—this is more common when reporting the energy from fossil fuels because it relates to the energy that is released when the fuel is burned; 1 kWh is equal to about 3,412 BTU. We prefer the units of electricity because most energy end use is transitioning toward electrification.

electric power generation. Approximately 30% of that electricity comes from renewable sources, predominantly hydropower and a small fraction from land-based wind energy and biomass (see the 2021 column in Table 5 in EIA 2022a). The remaining generation comes from fossil fuel sources. After accounting for conversion losses, this results in a statewide electricity consumption of about 5,900 gigawatt-hours (GWh), which is a small fraction of the total energy consumed by the state.

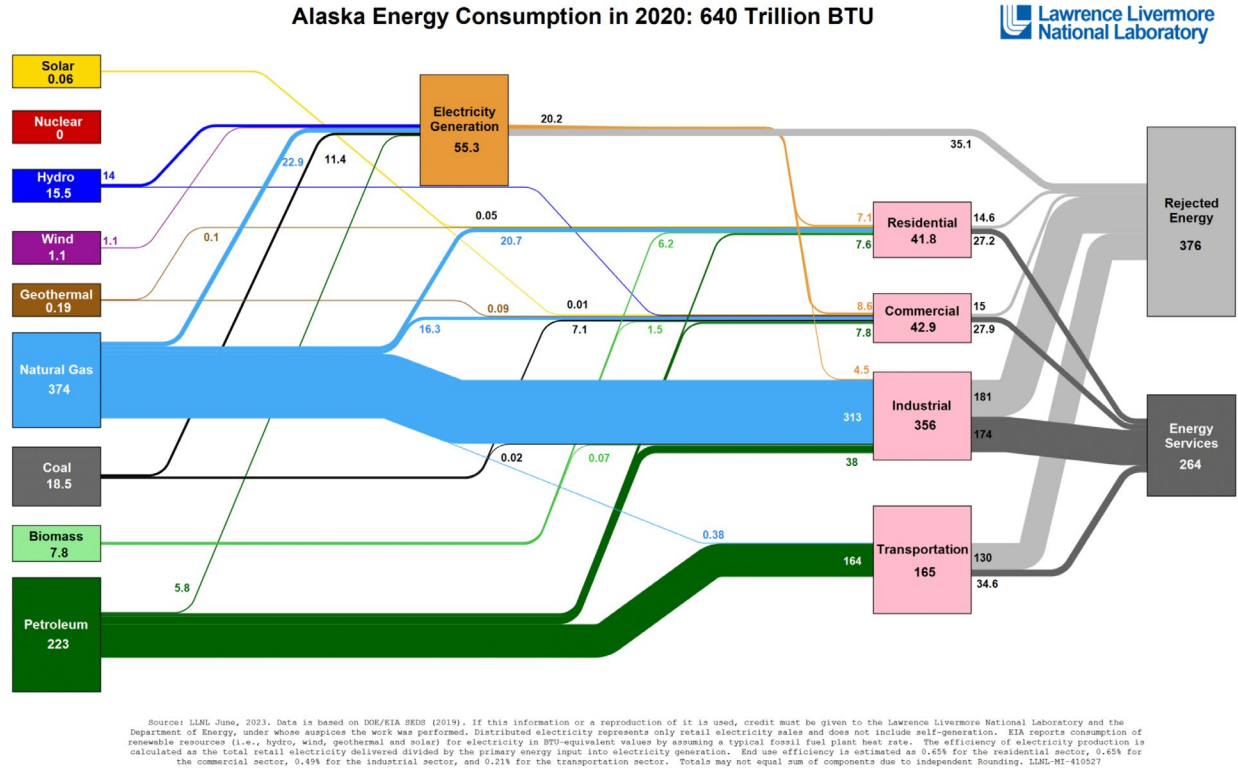

Figure ES-2. Alaska total energy consumption in 2020³
 Source: Lawrence Livermore National Laboratory (2023)

The primary demand for electricity is along the Alaska Railbelt grid where about two-thirds of the generation is natural gas from the Cook Inlet basin. The Alaska Railbelt grid (also referred to as the “Alaska Railbelt” or just “Railbelt”) is the name of the service areas of the six regulated public utilities that extend from Fairbanks to Anchorage and the Kenai Peninsula. Outside of the Railbelt, there are more than 200 remote electrical grids serving rural Alaska villages, where the cost of electricity can be up to 4 times more than for grid-connected communities due to the reliance on diesel generation and the cost to transport diesel fuel to remote locations (Allen et al. 2016). The State of Alaska’s Power Cost Equalization (PCE) Program subsidizes rural electricity prices (Alaska Energy Authority 2019). Outside the Railbelt, the largest electricity demand is in Southeast Alaska. **Table ES-1** summarizes electricity statistics for the Railbelt, rural PCE communities, and Southeast Alaska.

³ The 2023 energy flow chart published by Lawrence Livermore National Laboratory details the sources of energy production and how Americans are using energy. Note that the 376 trillion BTU of “Rejected Energy” is also the major contributor to carbon dioxide and other undesirable atmospheric emissions.

Table ES-1. Annual Alaska electricity consumption, rates, and primary source by region, 2019–2020

Region	Number of Communities	Electricity Consumption (GWh)	Average Residential Effective Rates (\$/kWh)*	Primary Generation Source
Rural PCE Communities**	194	475	\$0.28†	Diesel
Railbelt‡	92	4,407	\$0.20	Natural gas
Southeast and Other^	74	~1,000	\$0.11–\$0.27	Hydropower

kWh = kilowatt-hour

**2020 utility statistics data provided by Alaska Energy Authority

†Average rate that residents pay for the first 500 kWh after Power Cost Equalization (PCE) incentive

‡Data are for 2020 and from EIA Form 861

^Data from former Alaska Energy Data Gateway

Figure ES-2 shows that Alaska’s largest energy consumption sectors are industrial and transportation, which account for more than 81% of the energy consumed. The industrial sector primarily uses natural gas, much of which goes to power crude oil and natural gas production operations (EIA 2023a). The transportation sector is the predominant consumer of petroleum, including jet fuel (much of which supports Alaska’s unique role in cargo transport between Asia and North America) and distillate fuel oil (which includes diesel fuel and fuel oils, much of which is used for transportation and rural electricity generation).

Given that only 8.6% of Alaska’s total energy goes toward the generation of electricity, decarbonization strategies for Alaska will need to include the other high-carbon/high-energy use sectors, which will likely have a large impact on the state’s energy use profile over the next few decades. Load growth analysis performed by the University of Alaska at Fairbanks indicates that below a 90% adoption scenario for electric vehicles and residential heat pumps, the total electric load on the Railbelt will increase by 116%, with the peak electric demand increasing by 216% by 2050, assuming no significant changes in the population (Cicilio et al. 2023). Even with this expected doubling of the Railbelt electric load, additional decarbonization strategies will be needed such as non-grid offtake mechanisms to power large industrial loads, the production of clean hydrogen, and possibly carbon capture and sequestration options for natural gas.

Case Studies and Techno-Economic Analysis

As indicated earlier, the ocean renewable energy resource area in Alaska is expansive, and most of these resources would not be practical to develop commercially due to logistics, insufficient demand, etc. As such, this study focuses on techno-economic assessments for six selected case studies that could potentially have the highest merit in providing ocean-based renewable power. Case studies were selected based on resource quality, proximity to potential electricity offtake markets, and potential port capacity. Each offshore wind case study has an accompanying clean hydrogen market as one external market option for the energy produced. The case studies include:

- **Southcentral Alaska, Lower Cook Inlet – 3 Case Studies:** two offshore wind case study projects (one fixed-bottom in shallow water and one floating in deep water) and one tidal energy case study project and clean hydrogen potential that assumes the utilization of offshore wind energy. This location represents our primary option for offshore wind and tidal energy due to its proximity to the Railbelt. Under the 2050 Railbelt load growth scenario outlined by Cicilio et al.

(2023), energy produced at these sites has a well-defined route to market in a resource area for offshore wind and tidal energy that is among the best in the state.

- ***Alaska Peninsula and Eastern Aleutians, Dutch Harbor – 1 Case Study:*** one offshore wind case study project with clean hydrogen potential. This location represents a secondary option for offshore wind. The route to market is not fully investigated, but we consider the challenges of the more remote location and anticipate that most of the electricity would be used to produce clean hydrogen for industrial use or marine transportation.
- ***Western Alaska, Nome – 2 Case Studies:*** two offshore wind case study projects and clean hydrogen potential. This location represents another secondary option for offshore wind energy. As with Dutch Harbor, the route to market is not obvious, but the analysis considers the challenges of the more remote location and anticipates that most of the electricity would be used to produce clean hydrogen for industrial use or possibly other end-use applications such as marine transportation.

The case studies evaluated here were sited and sized so that the power could be delivered to the local market via a transmission line; the costs associated with the transmission line are included in the project cost estimates. In addition to techno-economic analysis, each case study provides some information about potential siting conflicts such as fishing (subsistence, personal use, and commercial) and the presence of rare, threatened, and endangered species, nesting birds, and other key natural resources.

The result of the techno-economic analysis for each case study is shown in **Table ES-2**. Each offshore wind project was sized to 1 GW because that is the typical size of U.S. projects under development.⁴ The tidal energy project in Cook Inlet is approximately 65 MW (in a 100-turbine array) to represent the first phase of what could be a multi-phased project. All the wind projects were determined to have capacity factors above 50%, and the tidal project has a capacity factor of 30%. The fixed-bottom offshore wind case study in the Southcentral Alaska (Lower Cook Inlet) location has the lowest levelized cost of energy (LCOE). Nevertheless, costs are marginally higher than for projects under development in the contiguous United States because their proximity to supply chains for vessels, ports, and large tier-1 components (e.g., substructures, blades, nacelles, towers) lowers risk and effort.⁵

⁴ The energy that could be produced from a 1-GW offshore wind plant in Cook Inlet is approximately equal to the 2020 electricity usage on the Railbelt. The Railbelt's electrical load is expected to more than double by 2050.

⁵ Levelized cost of energy (LCOE) = [(fixed charge rate × capital expenditures) + operational expenditures]/annual energy production. Section 5 includes a detailed discussion of the components that make up LCOE, including fixed charge rate, which is higher for tidal energy technologies than for more mature technologies like wind energy.

Table ES-2. Estimated LCOE in 2035 for 1-GW (1,000-MW) offshore wind case studies and a 100-device, 65-MW-array tidal case study

Estimated capital expenditures (CapEx) and operational expenditures (OpEx) are also given for each case study.

	Southcentral Alaska: Lower Cook Inlet Floating Offshore Wind Case Study	Southcentral Alaska: Lower Cook Inlet Fixed-Bottom Offshore Wind Case Study**	Alaska Peninsula and Eastern Aleutians: Dutch Harbor Floating Offshore Wind Case Study**	Western Alaska: Nome 1 Fixed-Bottom Offshore Wind Case Study**	Western Alaska: Nome 2 Fixed-Bottom Offshore Wind Case Study**	Southcentral Alaska: Lower Cook Inlet 65-MW Tidal Case Study
CapEx (\$/kW)	\$5,385	\$4,292	\$4,661	\$4,980	\$5,397	\$5,100
OpEx (\$/kW/yr)	\$65	\$65	\$59	\$73	\$74	\$163
LCOE (\$/MWh)*	\$100	\$83	\$87	\$103	\$106	\$280

*MWh = megawatt-hour

**These offshore wind scenarios would likely not exist without the clean hydrogen component; thus, the reader should not make direct comparisons across the LCOE numbers without adding in the cost of clean hydrogen production in these locations.

We investigated remote hydrogen production as one scenario to consider for external market potential and/or when the economics of building transmission to market are prohibitive. For each of the case studies, we estimate 2035 levelized cost of gaseous hydrogen (LCOH) to be \$7/kg–\$8/kg in the Southcentral Alaska (Lower Cook Inlet) and Western Alaska (Nome) case studies, and we estimate approximately \$12/kg for liquified hydrogen in the Alaska Peninsula and Eastern Aleutians (Dutch Harbor) case study. If incentives such as hydrogen production tax credits and renewable and storage investment tax credits are still available when projects are being developed, the LCOH can drop by ~\$2/kg hydrogen, assuming a 30-year plant lifetime. The LCOH is predominantly dependent on the LCOE and the capital cost of the offshore wind turbines; hence, renewable hydrogen affordability is closely related to capital cost reductions in renewables in the future. The total production across the case studies is ~0.5 million metric tons of hydrogen.

The cost estimates provided in **Table ES-2** and elsewhere in this report may be subject to substantial revision over time due to the dynamics of the domestic and global renewable energy markets while this report was being written. The absolute values of these cost estimates will likely be higher as additional market factors are taken into account, such as supply chain premiums, regional infrastructure deficiencies, transportation and shipping constraints, and gaps in workforce skills. In addition, the global offshore wind sector has recently encountered major economic headwinds resulting in rising costs and dynamic market conditions. A combination of high inflation, global supply chain disruptions, and soaring interest rates have resulted in offshore wind project cost increases of as much as 65%. Although commodity prices appear to have had a shorter-term impact on project costs and have returned to lower levels during 2022–2023, interest rates remain high in 2023, and long-term supply chain issues are likely to persist for many years. The Investment Tax Credit and bonus provisions under the Inflation Reduction Act might be able to mitigate this cost rise and perhaps uniquely help projects in Alaska for development timelines before the 2032 expiration. As such, the reader should focus on the relative differences among the geospatial cost differences in offshore wind when comparing different sites. Similarly, the reader should focus on the relative differences when comparing different technologies.

Stakeholder Engagement and Conflict Management Strategies

Alaska has the lowest population density of any state at 1.3 persons per square mile. Alaska’s population has the highest percentage of American Indian or Alaska Natives of any state (Rezal 2021). Moreover, the Alaska OCS supports numerous marine species, and those species contribute to a thriving commercial and subsistence fishing industry. Alaska communities and environments are especially vulnerable to climate change due to Alaska’s northern latitude and seasonal changes in sea ice (Alaska and a changing ... [date unknown]). Because of these unique attributes, it is important for BOEM to ensure equity and accessibility when recommending renewable energy transitions, and we recommend that BOEM take a collaborative, science-based, and inclusive approach to stakeholder engagement as it moves forward with supporting the energy transition.

Conclusions and Next Steps

Offshore wind is the most feasible option for renewable energy production in Alaska’s OCS in the next 10–20 years as compared to wave or tidal energy and remote clean hydrogen production. The technology is commercial, the estimated wind energy potential is substantial, and our LCOE estimates for all offshore wind case studies are lower than the LCOE of the tidal energy case study, though ocean energy project development scenarios in more remote locations like Dutch Harbor and Nome will require an alternative market (e.g., clean hydrogen) for project viability. The case studies in this report describe the challenges and opportunities of renewable energy projects in select regions of Alaska’s OCS. It would be prudent for BOEM to be prepared for possible future leasing of offshore wind areas in Cook Inlet as the market for renewable energy sources evolves over the next decade.

However, decision makers will need to compare these offshore wind costs to costs for utility-scale, land-based wind energy development to determine the best approach for full electrification (e.g., electric vehicles, heat pumps) of the Railbelt service area. To help provide this information, NREL is also finalizing an independent capacity expansion analysis (expected completion early 2024) of different renewable energy scenarios that could meet an 80% renewable portfolio standard on the Alaska Railbelt by 2040. The study seeks to identify the least-cost investment strategy for the Railbelt to reliably meet its electrical demand every year between now and 2040. The two Lower Cook Inlet offshore wind case studies in this report will potentially be the most cost-competitive compared to other energy generation options for Alaska. It would be useful to research the economic viability of smaller wind farms, curtailment, and the quality of future wind scenarios in future analyses.

Alaska’s wave energy resource is significant but is generally far from any identifiable markets. Also, wave energy technologies are still in their early stages of development, with technology commercialization unlikely before 2035. However, wave energy is more predictable than other renewable energy resources—especially because wave energy resources can be estimated from satellite observations. We recommend that BOEM maintain current information about the development of these technologies—especially via communication with the U.S. Department of Energy’s Water Power Technologies Office—because if future technology advances are successful, wave energy could complement other variable power sources like wind and solar.

Tidal energy resources are relatively small compared to offshore wind and wave energy, and the technology is still in a precommercial state, but Alaska has some of the world’s best tidal resources. This superlative is generally accepted within the global industry and is based on the large quantity of resources located in Cook Inlet close to the Railbelt as well as the excellent resource quality based on high water

current speeds, relatively unconflicted siting options,⁶ and the highly predictable and reliable nature of the resource. At present, the most promising sites for early tidal energy projects are in state waters, but as the technology matures and devices grow in size, Alaska's OCS waters could become increasingly attractive for tidal energy development. NREL and the Alaska Center for Energy and Power are in the process of finalizing a road map for developing tidal energy projects in Cook Inlet (expected completion early 2024). That road map shows that the critical next step for tidal energy development in Alaska is to execute technology demonstration projects (i.e., <1 MW) that are designed to identify which technologies work in Alaska waters. This is also likely to involve modifying or refining existing designs to make them robust enough for Alaska conditions (e.g., ice and sediment). We recommend that BOEM continue to stay involved with working groups focused on tidal energy and stay educated about the progress of demonstration projects so that they are prepared to review applications to develop commercial projects when the time comes.

As the immense ocean-based resources could enable electricity production greater than the capacity of the Railbelt, clean hydrogen is one option that can create a parallel path to serve other end uses. Longer-term advances in hydrogen technology may create demand for the development of more remote offshore wind farms to serve a hydrogen export market in or outside of Alaska by 2040. End uses for clean hydrogen statewide were identified and estimated to range from 4,800 to 83,000 GWh annually. For more information on hydrogen market potential in Alaska, BOEM could consult the DOE Arctic Energy Office's *Alaska Hydrogen Opportunities Report*, which was under production at the time of the writing of this report. The levelized cost of hydrogen is highly dependent on the source electricity LCOE; therefore, driving down those costs (i.e., offshore wind) would result in more competitive hydrogen costs, which could in turn drive the hydrogen market potential.

Other possibilities also exist for monetizing the energy produced, including the development of local infrastructure for mineral smelting, seawater mining, aquaculture, marine carbon dioxide removal, fish processing, data centers, or the production of some other industrial or agricultural product (e.g., urea) with high electricity demand.

BOEM Alaska should assemble a task force and/or an ocean energy developer's forum to share the information collected and assess interest in demonstrating ocean energy potential through a pilot study or by supporting other critical research initiatives. There could also be value for BOEM in strengthening ocean energy-related partnerships with the U.S. Department of Energy's Arctic Energy Office, Water Power Technologies Office, and Hydrogen and Fuel Cell Technologies Office.

⁶ Tidal energy devices in Cook Inlet can be submerged to depths below where they would interfere with maritime navigation, and because Cook Inlet is very large relative to the energy that would be extracted, the impacts to currents and tides would be negligible. As they would not be visible from the surface, tidal energy devices may have lower social acceptance and permitting barriers compared to large wind projects above the water.

Contents

List of Figures	xi
List of Tables	xii
List of Abbreviations and Acronyms	xiv
1 Introduction	1
2 Resource Assessment	3
2.1 Alaska Ocean Energy Resources	3
2.1.1 Alaska’s Offshore Wind Resource	5
2.1.2 Alaska’s Wave Energy Resource	6
2.1.3 Alaska’s Tidal Energy Resource	7
3 Market Assessment	10
3.1 Electricity Use in Alaska	12
3.1.1 Rural Power Cost Equalization Communities	13
3.1.2 Railbelt	15
3.1.3 Southeast and Other Communities	18
3.2 Additional Marine Renewable Energy Supply Opportunities	18
3.2.1 Decarbonizing Energy Use	18
3.2.2 Clean Hydrogen Opportunities	19
3.3 Ocean Energy Resources at a Regional Level	20
3.3.1 Southcentral Alaska	20
3.3.2 Alaska Peninsula and Eastern Aleutians	25
3.3.3 Western Alaska	29
3.3.4 Southeast Alaska	31
4 Case Studies and Analysis Performed	35
4.1 General Case Study Information	35
4.2 Site-Specific Information	36
4.2.1 Ports	36
4.2.2 Case Studies in Southcentral Alaska (Lower Cook Inlet)	38
4.2.3 Case Study in Alaska Peninsula and Eastern Aleutians (Dutch Harbor)	44
4.2.4 Case Studies in Western Alaska (Nome)	49
5 Techno-Economic Analysis	55
5.1 Offshore Wind	56
5.1.1 Wind Power Plant Parameters	56
5.1.2 Financing Terms	58
5.1.3 Capital Expenditures	58
5.1.4 Operational Expenditures	60
5.1.5 Annual Energy Production	61
5.1.6 Results and Discussion	62
5.2 Tidal Energy	65
5.2.1 Tidal Power Plant Parameters	65
5.2.2 Financing Terms	67
5.2.3 Capital Expenditures	67
5.2.4 Operational Expenditures	70
5.2.5 Annual Energy Production	71
5.2.6 Results and Discussion	74
5.3 Hydrogen Production	75

5.3.1	Methodology	76
5.3.2	Configurations and Locations	77
5.3.3	Techno-Economic Parameters.....	79
5.3.4	Results and Discussion	81
6	Stakeholder Engagement and Conflict Management.....	85
6.1	Stakeholders	85
6.2	Energy Justice.....	89
6.3	Recommended Stakeholder Engagement and Conflict Management Strategies	90
6.3.1	Stakeholder Engagement Strategies	90
6.3.2	Conflict Management Strategies	91
7	Conclusions and Suggested Next Steps	93
8	References	95
Appendix A: Community Distance to Nearest Offshore Wind Resource		102

List of Figures

Figure ES-1. Offshore wind and marine energy resource totals by BOEM planning area	ii
Figure ES-2. Alaska total energy consumption in 2020	iii
Figure 1. Offshore wind and marine energy resource totals by BOEM planning area	4
Figure 2. Population, planning regions, and infrastructure of Alaska	11
Figure 3. Total energy use in Alaska by source, 2020.....	12
Figure 4. Total energy use in Alaska by sector, 2020.....	12
Figure 5. Net electricity generation in Alaska by source, 2020.....	13
Figure 6. Electricity generation mix for rural PCE communities, July 2019–June 2020	14
Figure 7. Power infrastructure of Alaska’s Railbelt Grid	16
Figure 8. Electricity generation mix for Railbelt communities, 2020	17
Figure 9. Alaska total energy consumption in 2020	19
Figure 10. Simulated offshore wind energy resource of Southcentral Alaska (at 100 m)	22
Figure 11. Simulated wave energy resource of Southcentral Alaska	23
Figure 12. Simulated tidal energy resource of Southcentral Alaska	24
Figure 13. Simulated offshore wind energy resource of Alaska Peninsula and Eastern Aleutian Islands (at 100 m)	26
Figure 14. Simulated wave energy resource of Alaska Peninsula and Eastern Aleutian Islands	27
Figure 15. Simulated tidal energy resource of Alaska Peninsula and Eastern Aleutian Islands	28
Figure 16. Simulated offshore wind energy resource of Western Alaska (at 100 m)	30
Figure 17. Simulated offshore wind energy resource of Southeast Alaska (at 100 m).....	32
Figure 18. Simulated wave energy resource of Southeast Alaska	33
Figure 19. Simulated tidal energy resource of Southeast Alaska	34
Figure 20. Maps showing locations of case studies	36
Figure 21. (a) Average simulated wind speeds per year and (b) annual cycle of average simulated wind speeds per month at the Southcentral Alaska case study sites in the Lower Cook Inlet.	38
Figure 22. Wind roses of wind directions for the Southcentral Alaska offshore wind (a) shallow-water case study site and (b) deep-water case study site in the Lower Cook Inlet.....	39
Figure 23. Average simulated wind speeds at 100 m for Southcentral Alaska during daytime and nighttime, and during spring, summer, fall, and winter	40
Figure 24. Port of Alaska.....	41
Figure 25. (a) Average simulated wind speeds per year and (b) annual cycle of average simulated wind speeds per month at the Alaska Peninsula and Eastern Aleutians case study site at Dutch Harbor.	45
Figure 26. Wind rose for Alaska Peninsula and Eastern Aleutians case study site at Dutch Harbor.....	46
Figure 27. Port at Dutch Harbor	47
Figure 28. (a) Average simulated wind speeds per year and (b) annual cycle of average simulated wind speeds per month at the Western Alaska case study sites in Nome.....	50

Figure 29. Wind roses of wind directions for the Western Alaska case study sites: (a) Nome 1 and (b) Nome 2	51
Figure 30. Port of Nome	51
Figure 31. Port of Nome proposed expansion	52
Figure 32. Offshore wind turbine substructure types	57
Figure 33. (a) Average simulated wind speeds per year and (b) annual cycle of average simulated wind speeds at all offshore wind case study locations	61
Figure 34. LCOE for land-based and offshore wind sites in the Alaska Railbelt	64
Figure 35. Reference Model 1	66
Figure 36. Tidal case study bathymetric map	67
Figure 37. Lower Cook Inlet current speed frequency distribution	72
Figure 38. Annual energy production for the Southcentral Alaska Lower Cook Inlet tidal energy case study	72
Figure 39. Southcentral Alaska Lower Cook Inlet tidal energy case study single device power curve	73
Figure 40. Tidal energy LCOE estimates over time	74
Figure 41. Renewable portfolio standard scenarios	75
Figure 42. Maximum hydrogen production potential from Alaska marine energy resources	76
Figure 43. RODEO model inputs and outputs	77
Figure 44. Configurations for this project	78
Figure 45. Hydrogen production locations and potential storage and demand locations: Southcentral Alaska (Lower Cook Inlet)	79
Figure 46. Hydrogen production locations and potential storage and demand locations: Alaska Peninsula and Eastern Aleutians (Dutch Harbor) and Western Alaska (Nome)	79
Figure 47. Levelized cost of hydrogen for Dutch Harbor, Nikiski, Homer, Nome 1, and Nome 2 locations for 2035	82
Figure 48. Comparison between LCOH with onshore and offshore electrolysis for Dutch Harbor	83
Figure 49. Potential hydrogen demand scenarios for Alaska by 2035 using conservative, medium, and optimistic scenarios	84
Figure 50. Alaska stakeholders for ocean-based renewable energy technologies	85

List of Tables

Table ES-1. Annual Alaska electricity consumption, rates, and primary source by region, 2019–2020	iv
Table ES-2. Estimated LCOE in 2035 for 1-GW (1,000-MW) offshore wind case studies and a 100-device, 65-MW-array tidal case study	vi
Table 1. Alaska’s ocean energy resources	3
Table 2. Area of the wind resource greater than or equal to 7 m/s and a potential installed capacity of 3 MW/km ² by depth class	5
Table 3. Installed offshore wind technical capacity by depth class, assuming 3 MW/km ² potential installed capacity	6
Table 4. Installed technical capacity of wave energy resources in Alaska’s OCS	7
Table 5. Technical capacity of tidal resources in Alaska’s OCS	8

Table 6. Annual Alaska electricity consumption, rates, and primary source by region, 2019–2020	13
Table 7. Annual electricity generation in large, rural communities, July 2019–June 2020	14
Table 8. Railbelt electricity sales and rate by utility in 2020	17
Table 9. Annual Alaska electricity consumption, rates, and primary source for non-PCE communities in the southeast and other regions.....	18
Table 10. Criteria for offshore wind ports.....	37
Table 11. Statistics for the case study ports assessed.....	37
Table 12. Subsistence and commercial fishing species of the Lower Cook Inlet.....	42
Table 13. Expanded list of threatened and endangered species and critical habitat for the Southcentral Alaska case studies location	43
Table 14. Subsistence and commercial fishing species in Dutch Harbor.....	48
Table 15. Expanded list of threatened and endangered species and critical habitat for the Alaska Peninsula and East Aleutians case study location.....	49
Table 16. Subsistence and commercial fishing species in Norton Sound	53
Table 17. Expanded list of threatened and endangered species and critical habitat for the Western Alaska case study	54
Table 18. Offshore wind case study location characteristics	57
Table 19. Offshore wind financing inputs.....	58
Table 20. Capital cost adjustments for Alaska offshore wind case studies	59
Table 21. CapEx breakdown for 1-GW offshore wind power plants in 2035.....	60
Table 22. Operational cost adjustments for Alaska offshore wind energy.....	61
Table 23. Loss factors for Alaska offshore wind energy	62
Table 24. Estimated LCOE in 2035 for 1,000-MW offshore wind case studies.....	62
Table 25. Estimated LCOE in 2035 for 105-, 195-, and 1,000-MW offshore wind power plants in Cook Inlet.....	63
Table 26. Estimated LCOE for land-based wind across the Railbelt, present–2040.....	65
Table 27. Tidal project development costs	68
Table 28. Tidal project installation costs	69
Table 29. Tidal case study project O&M cost breakdown.....	70
Table 30. Tidal case study project economics	71
Table 31. Major assumptions used in the hydrogen techno-economic assessment of a 1-GW offshore wind farm.....	80
Table 32. Stakeholder groups by location.....	86
Table 33. Regulatory agencies involved in authorizing projects on the OCS.....	88
Table 34. Examples of stakeholders and levels of engagement	91
Table A-1. Community distance to nearest offshore wind resource	102

List of Abbreviations and Acronyms

ADFG	Alaska Department of Fish and Game
AEP	annual energy production
ATB	Annual Technology Baseline
BOEM	Bureau of Ocean Energy Management
BTU	British thermal unit
CapEx	capital expenditures
DOE	U.S. Department of Energy
EEZ	exclusive economic zone
EIA	U.S. Energy Information Administration
ESA	Endangered Species Act
FCR	fixed charge rate
ft	foot
GW	gigawatt
GWh	gigawatt-hour
H ₂	hydrogen
HFTO	Hydrogen and Fuel Cell Technologies Office
IEA	International Energy Agency
ITC	investment tax credit
kW	kilowatt
kWh	kilowatt-hour
LCOE	levelized cost of energy
LCOH	levelized cost of hydrogen
MW	megawatt
MWh	megawatt-hour
NGO	nongovernmental organization
NMFS	National Marine Fisheries Service
NREL	National Renewable Energy Laboratory
O&M	operations and maintenance
OCS	Outer Continental Shelf
OpEx	operational expenditures
ORBIT	Offshore Renewables Balance-of-system and Installation Tool
PCE	Power Cost Equalization
POI	point of interconnection
psf	pounds per square foot
PTC	production tax credit
RODeO	Revenue, Optimization, and Device Operation
RPS	renewable portfolio standards
TRL	technology readiness level
TWh	terawatt-hour
USFWS	U.S. Fish and Wildlife Service

1 Introduction

The National Renewable Energy Laboratory (NREL) conducted this study for the U.S. Department of the Interior, Bureau of Ocean Energy Management (BOEM) under an interagency agreement with the U.S. Department of Energy (DOE). This study assesses the feasibility of ocean-based renewable energy sources for decarbonizing the energy supply, increasing coastal resilience, and building energy security and energy independence in Alaska.

The technologies considered in this study were limited to the ocean because of BOEM’s Outer Continental Shelf (OCS) jurisdiction, although Alaska also has vast land-based renewable energy resources—for example, utility-scale land-based wind could have strong economic potential in regions where it could be connected to the Alaska Railbelt electrical grid. The Alaska Railbelt grid (also referred to as “the Alaska Railbelt” or just “Railbelt”) is the service areas of the six regulated public utilities that extend from Fairbanks to Anchorage and the Kenai Peninsula (a map of the Railbelt grid is shown in Section 3.1.2). Offshore wind, ocean wave, and tidal energy were the primary technologies selected for study based on NREL’s understanding of the available ocean-based resources in Alaska.

Practical methods for delivering energy from these sources to end users were also considered, including the potential for clean hydrogen fuel production, distribution, and end-use adoption opportunities. Most of the electricity used in Alaska is generated and consumed on the Railbelt grid, which connects the region surrounding Anchorage. Cook Inlet, in particular, has abundant offshore wind and tidal energy resources and also has the benefit of being adjacent to the southern half of the Railbelt. Note that BOEM has authority in the OCS, which is located in Lower Cook Inlet (refer to maps in Section 3.3.1).

The technology readiness levels (TRLs) of offshore wind energy, wave energy, and tidal energy technologies are all very different (for definitions of TRLs 1–9, refer to [What are ... c2023]). Offshore wind energy is at TRL 9, in that it is a proven technology with more than 59 gigawatts (GW) installed globally using both fixed-bottom and floating platforms (Musial et al. 2023). About 200 megawatts (MW) of global installation comes from floating wind turbines. By contrast, wave energy technologies are in the early to middle stages of technology readiness (TRL 1–6). There is a diverse set of prototype concepts, but few concepts have progressed beyond tank testing to open-water demonstrations. Because of limited published data for the demonstration projects that have taken place, the technical performance and energy costs of wave energy technologies remain unknown.

Tidal energy technologies are more mature than wave energy technologies (TRL 5–8) but are not yet commercial like offshore wind technologies. Tidal energy is relatively mature compared to wave energy for two reasons. First, tidal technologies are similar enough to wind turbines—tidal devices are sometimes called “underwater wind turbines”—that it has been possible to leverage engineering knowledge from wind technology. Second, tidal technologies have received larger investment, especially in Europe (Janssen and Simon 2020). In the last few years, tidal energy technologies have benefited from improved reliability and technical performance over time scales of a few months to a year or two. The next step toward commercializing tidal technologies will be to demonstrate reliability over 10- to 20-year time scales and to drive down the costs, particularly for operations and maintenance. To address this need, DOE released a Funding Opportunity Announcement (Funding ... 2023) to support the demonstration and commercialization of tidal energy technologies.

Finally, with respect to hydrogen technologies, the production of hydrogen with renewable energy has been tested using a proton exchange electrolyzer. The technology has been proven in an operational environment and has reached a high TRL of 7–9 (ARUP 2022, Expertise for ... c2023).

The objectives of the feasibility study were to:

- Identify the individual energy markets, stakeholders, and communities involved (e.g., reference site for each market) based on statistical analysis of energy costs, average load, regional demographics, and physical constraints.
- Describe some key natural and human environmental uses of the selected areas and unique management considerations.
- Assess relevant ocean energy renewable resources and technologies for each case study, and define requisite conditions for their emplacement including constraints, risks, and economic feasibility.
- Perform a bottom-up life cycle economic analysis for each ocean energy technology determined to be technically feasible to estimate the cost of the most promising technologies and assess economic feasibility relative to local conditions.
- Identify capacity-building requirements to ensure sustainability of renewable energy projects in various communities and energy markets.
- Maintain continuous communication and outreach with Alaska clean energy stakeholders to ensure the social and economic alignment of proposed opportunities that can serve Alaska locations with the greatest needs through implementation of actionable strategies.

Following this Introduction, Section 2 details Alaska’s offshore wind, wave, and tidal energy resources. Section 3 is a market assessment of the project area to determine the market potential for offshore renewable energy projects in and around Alaska. Section 4 describes selected case study locations. The techno-economic analyses of ocean energy resource projects in each of the case study locations are provided in Section 5. Section 6 discusses best practices and Alaska-specific opportunities for stakeholder engagement and conflict management as it relates to development of ocean energy projects in Alaska. The report culminates in a summary of conclusions and next steps in Section 7.

2 Resource Assessment

2.1 Alaska Ocean Energy Resources

Alaska’s coastline is more than 47,00 miles long—including islands, inlets, and shoreline (Geography ... [date unknown])—which is longer than the coastline of the rest of the nation. Accordingly, Alaska’s OCS area is 1.4 million square miles, which is more than twice the area of the state and more than half the area of the 48 contiguous United States.

Table 1 gives Alaska’s total resource of offshore wind, wave, and tidal energy, the percentage of the resource compared to U.S. electricity generation capacity, and the factor of the resource compared to Alaska’s electricity generation capacity.

Table 1. Alaska’s ocean energy resources

All values are listed to two significant figures, so totals may not equal sums.

Energy Source	Total Resource (GW; 3,800 GW total)	Net Energy Potential (GWh)**	Compared to U.S. Electricity Generation Capacity	Net Energy Potential Compared to Alaska Electricity Generation (5,882 GWh)*
Offshore Wind	3,400 (88% of total)	12,000,000	280%	2000x
Wave	370 (10% of total)	970,000	30%	170x
Tidal	79 (2% of total)	210,000	7%	35x

Note: The 2021 U.S. electricity generation capacity was 1,200 GW (rounded to hundredth place), including that from small-scale solar (U.S. Energy Information Administration [EIA] 2023b). Alaska’s 2021 electricity generation capacity was 2.7 GW (EIA 2022a).

*GWh = gigawatt-hour

**Net energy potential (rounded to the nearest thousands) is calculated by taking the resource available in gigawatts and multiplying by the hours in a year and the capacity factor of the energy source (offshore wind assumes a capacity factor of 40% [though capacity factors of 50% can be attained according to the analysis herein], wave assumes 30%, and tidal assumes 30%).

Figure 1 summarizes the technical power potential of Alaska’s resources of wind, wave, and tidal energy per BOEM OCS Planning Area. In total, Alaska state and federal waters are estimated to possess 3,800 GW of *potential* wind, wave, and tidal energy capacity spread across BOEM’s OCS planning areas (Doubrawa et al. 2017, Kilcher et al. 2021). For wave resource estimation, we modify the approach taken by Kilcher, Fogarty, and Lawson (2021)—which was focused on the inner-shelf—in order to focus on the outer continental shelf.

The potential energy capacity is more than 3 times the *actual* total generation capacity of the nation (1,200 GW) (EIA 2023b). Note that accessing the ocean energy resource potential requires a substantial investment in development and interconnection to the grid. Additionally, due to constraints like long distances to load, poor economic viability, and conflicts with other ocean users and wildlife, only a small fraction of this resource can practically be developed.

Our project assesses a subset of this area extending from the Alaska coastline to the U.S. exclusive economic zone (EEZ), 200 nautical miles from shore (**Figure 1**). The areas of focus for this project are south of the Bering Strait and approximately east of the 169th meridian. The data are shown herein in integrated maps and tables for BOEM OCS planning areas with the goal of facilitating the assessment of individual load scenarios.

Technical Power Potential of Alaska Marine Energy Resources

(in GW)

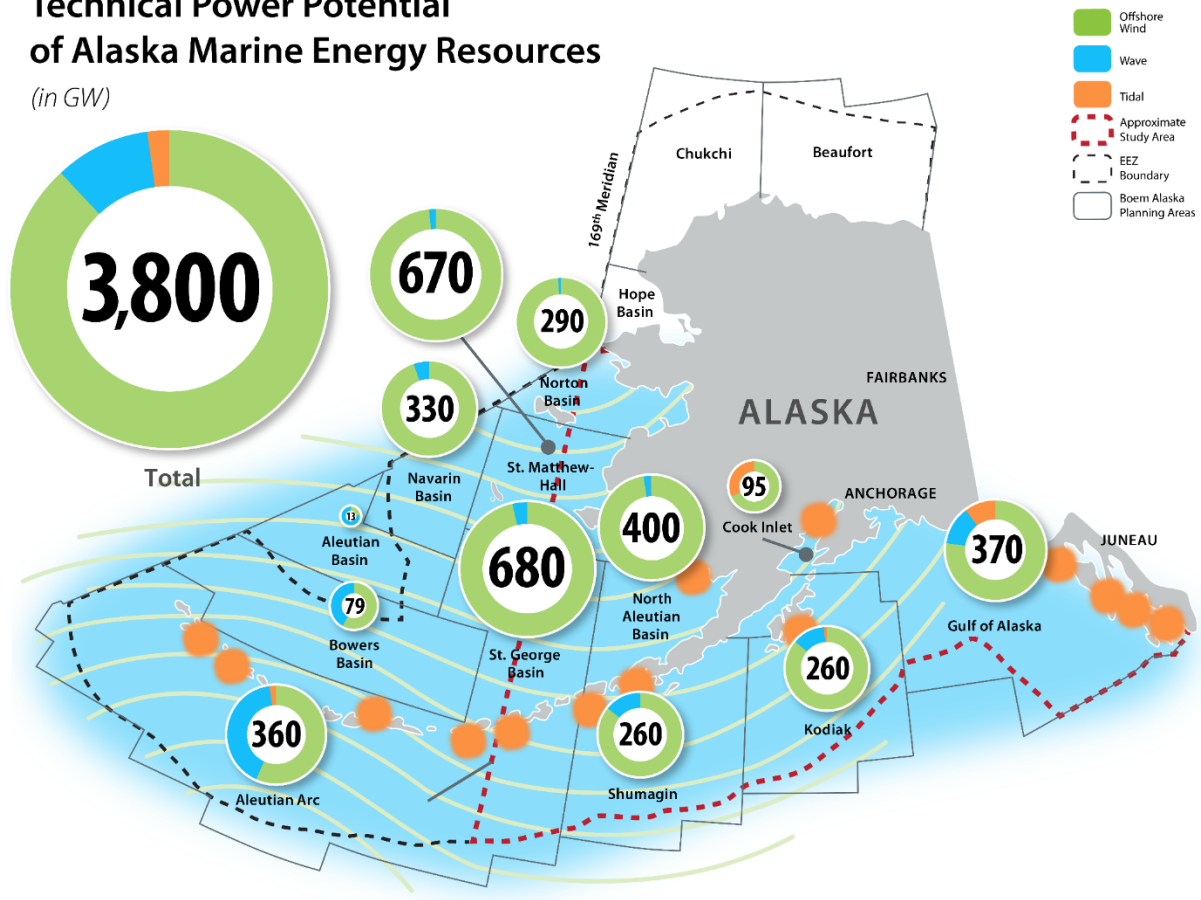

Figure 1. Offshore wind and marine energy resource totals by BOEM planning area

Resource totals are given in gigawatts. Dotted lines show the approximate study area (red) and the exclusive economic zone boundary (black). Data from Doubrava et al. (2017) and Kilcher et al. (2021). Illustration by NREL.

The terms “theoretical resource,” “technical resource,” and “practical resource” are used throughout the report and are defined as follows (International Electrotechnical Commission 2020):

- **Theoretical resource** is the energy available in the resource and will be the largest of theoretical, technical, and practical resource estimates. The accuracy of the theoretical resource estimate depends on the temporal and spatial model resolutions.
- **Technical resource** is the proportion of the theoretical resource that can be captured using existing technology options without considering external constraints such as socioeconomic, environmental, regulatory, and other competing-use constraints. Technical resource will always be smaller than theoretical resource estimates and larger than practical resource estimates. Estimation of the technical resource is a function of the type of technology being modeled and the model’s ability to sufficiently quantify the effect of the technology on the theoretical resource.
- **Practical resource** is the proportion of the technical resource that is available after consideration of external constraints. Practical resource will always be the smallest of theoretical, technical, and practical resource estimates.

Note that “technical capacity” (in gigawatts) is the amount of generation capacity that would need to be installed to harness the technical resource (in gigawatt-hours per year [GWh/yr]).

2.1.1 Alaska's Offshore Wind Resource

To estimate the wind resource for offshore regions in Alaska, we used Weather Research and Forecasting Model simulations conducted at the National Center for Atmospheric Research (Doubrawa et al. 2017, Lee et al. 2019). Simulated wind speed and direction at 100 and 120 m are available for 14 years (September 2002–August 2016) on a 4-km grid every 6 hours. Such multiyear time series capture representative long-term mean annual wind speeds by taking interannual variability into account. Using these long-term Weather Research and Forecasting Model simulations, we calculated the technical offshore wind resource for all BOEM OCS planning areas south of the Bering Strait.

The total technical offshore wind resource areas were calculated for the BOEM OCS planning areas (Table 2 and Table 3) and are listed per water depth class. Water depths were derived from General Bathymetric Chart of the Oceans data. For these calculations, we used a definition for significant depth as being greater than 40 m and a wind speed cutoff of greater than or equal to 7 m/s, and we assumed 3 MW/km² for converting windy water areas to installed capacity based on a national offshore wind resource assessment (Musial et al. 2016). We used a depth interval of 100 m to separate out some of the shallower waters. Cutoffs of 700 m, 1,000 m, and 1,300 m were chosen with the goal of understanding where floating and fixed-bottom turbines could be beneficial.

Table 2. Area of the wind resource greater than or equal to 7 m/s and a potential installed capacity of 3 MW/km² by depth class

BOEM OCS Planning Area	Area of Wind Resource (km ²) for Depth Class 0–40 m	Area of Wind Resource (km ²) for Depth Class 40–100 m	Area of Wind Resource (km ²) for Depth Class 100–700 m	Area of Wind Resource (km ²) for Depth Class 700–1,000 m	Area of Wind Resource (km ²) for Depth Class 1,000–1,300 m	Area of Wind Resource Total by Region (km ²)
Aleutian Arc	2,387.3	7,813.7	39,762.2	9,774.2	8,991.5	68,728.9
Aleutian Basin	0.0	12.9	378.1	211.3	374.9	977.3
Bowers Basin	2.0	50.5	6,145.1	4,243.1	4,932.1	15,372.7
Chukchi Sea	2.1	0.0	0.0	0.0	0.0	2.1
Cook Inlet	4,006.1	3,818.9	13,685.7	0.0	0.0	21,510.7
Gulf of Alaska	748.7	11,712.0	74,945.4	4,243.7	4,567.2	96,217.0
Kodiak	4,086.2	20,804.6	39,826.0	5,222.2	4,053.0	73,992.1
Navarin Basin	629.3	30,473.4	69,695.3	2,363.1	2,262.9	105,424.1
North Aleutian Basin	43,669.1	85,732.3	1,988.2	0.0	0.0	131,389.6
Norton Basin	72,336.0	24,849.3	0.0	0.0	0.0	97,185.3
Shumagin	8,486.4	23,285.9	37,836.5	2,657.8	2,726.1	74,992.6
St. George Basin	7,616.4	100,114.6	98,802.0	5,649.4	5,564.9	217,747.4
St. Matthew-Hall	104,588.9	107,842.5	8,456.6	0.0	0.0	220,888.1
Total by Depth	248,558.7	416,510.7	391,521.0	34,364.8	33,472.6	1,124,427.8

Table 3. Installed offshore wind technical capacity by depth class, assuming 3 MW/km² potential installed capacity

BOEM OCS Planning Area	Installed Capacity (MW) for Depth Class 0–40 m	Installed Capacity (MW) for Depth Class 40–100 m	Installed Capacity (MW) for Depth Class 100–700 m	Installed Capacity (MW) for Depth Class 700–1,000 m	Installed Capacity (MW) for Depth Class 1,000–1,300 m	Installed Capacity Total by Region (MW)
Aleutian Arc	7,162.0	23,441.1	119,286.5	29,322.7	26,974.4	206,186.7
Aleutian Basin	0.0	38.7	1,134.4	634.0	1,124.7	2,931.8
Bowers Basin	6.0	151.4	18,435.2	12,729.2	14,796.3	46,118.2
Chukchi Sea	6.3	0.0	0.0	0.0	0.0	6.3
Cook Inlet	12,018.3	11,456.7	41,057.1	0.0	0.0	64,532.1
Gulf of Alaska	2,246.0	35,136.1	224,836.3	12,731.1	13,701.5	288,651.0
Kodiak	12,258.7	62,413.9	119,478.0	15,666.7	12,159.0	221,976.3
Navarin Basin	1,888.0	91,420.1	209,085.9	7,089.3	6,788.8	316,272.2
North Aleutian Basin	131,007.3	257,197.0	5,964.5	0.0	0.0	394,168.8
Norton Basin	217,008.1	74,547.9	0.0	0.0	0.0	291,556.0
Shumagin	25,459.3	69,857.6	113,509.4	7,973.3	8,178.4	224,977.9
St. George Basin	22,849.3	300,343.9	296,406.0	16,948.2	16,694.6	653,242.1
St. Matthew-Hall	313,766.7	323,527.6	25,369.9	0.0	0.0	662,664.2
Total by Depth	745,676.0	1,249,532.0	1,174,563.1	103,094.5	100,417.7	3,373,283.4

Alaska’s potential offshore wind resources far exceed the current energy demand of coastal communities and infrastructure around the state. However, many coastal communities are still a long distance from technically viable project sites, so the challenge is identifying communities that could benefit from offshore wind development. We take a first step at this work in the Appendix by providing data from the technical potential analysis; **Table A-1** quantifies the land and water distance of communities to the nearest offshore wind resource and reports the wind speed value of the closest resource.

2.1.2 Alaska’s Wave Energy Resource

Alaska’s wave energy resource was estimated using 32 years (January 1979–December 2010) of Wave Watch III model output (Kilcher et al. 2023). The data from this model were stored hourly throughout that period and included directional spectra of wave energy to facilitate calculation of the total resource for arbitrary boundaries. Those directional spectra were then integrated across each of the BOEM OCS planning areas to calculate their total theoretical resource potential using the methodology described in Kilcher et al. (2023).

To estimate the technical resource and technical capacity, we modify the approach taken by Kilcher et al. (2021)—which was focused on the inner shelf—to focus on the outer continental shelf. In this work, we

assume that the technical resource is equal to 50% of the theoretical resource. We then assume that the devices to generate this power will have a capacity factor of 30% (capacity factor is the ratio of actual energy produced to energy that could have been produced at continuous full power). Based on these assumptions, the “technical capacity” of wave energy is equal to $0.5/0.3 = 1.66$ times the theoretical resource. That is, a capacity equal to 166% of the theoretical resource is necessary to capture 50% of that resource. The results generated by this approach are shown in **Table 4**. Even though the analysis area is different, and the methods differ slightly, these results are consistent with the results of Kilcher et al. (2021).

Table 4. Installed technical capacity of wave energy resources in Alaska’s OCS

BOEM OCS Planning Area	Theoretical Resource (Average Power, GW)	Technical Resource (GWh/yr)	Technical Capacity (GW)
Aleutian Arc	89.2	390,900	148.7
Aleutian Basin	6.1	26,800	10.2
Bowers Basin	19.6	85,800	32.6
Cook Inlet	No Data*		
Gulf of Alaska	27.5	120,400	45.8
St. George Basin	14.6	64,000	24.4
Kodiak	19.8	86,700	33.0
St. Matthew-Hall	5.7	24,900	9.5
North Aleutian Basin	5.4	23,500	9.0
Navarin Basin	10.5	45,900	17.5
Norton Basin	1.5	6,600	2.5
Shumagin	22.4	97,900	37.3
Total	222.3	973,500	370.4

* The wave dataset used for calculating wave energy resources does not include Cook Inlet because it was designed to focus on regions where wave energy is greater than 10 kW/m, and most of Cook Inlet does not meet this threshold (as detailed in Section 3.3.1).

2.1.3 Alaska’s Tidal Energy Resource

Tidal energy is harnessed by building arrays of tidal energy devices (which typically look like underwater wind turbines), in the narrow channels between two large bodies of water. As the tides push water through these narrow channels, the flowing water turns the turbines, and the turbines generate electricity. The tidal resource estimates presented here are based on numerical model simulations of tidal flows along the entire Alaska coastline that were validated against tidal elevation time series (Haas et al. 2011). The theoretical resource was estimated from these models based on the volume flow through the channel and the difference in tidal amplitude across the channel (Garret and Cummins 2005). Haas et al. (2011) estimate Alaska’s tidal energy resources along the entire southern coastline—from Southeast Alaska to the end of the Aleutians—and within Bristol Bay, but they do not estimate tidal resources north of Cape Newenham.

These data were grouped into the appropriate BOEM OCS planning areas; we also included tidal resource from within state waters adjacent to each OCS planning area. We included resource “adjacent to OCS areas but in state waters” for two reasons: (1) it is not straightforward to separate the tidal resource that is

within state waters from the resource in federal waters and (2) to give a more comprehensive picture of the tidal energy opportunity in Alaska waters as a whole. To estimate technical capacity (as with wave energy), we assume it will be possible to capture 50% of the theoretical resource with turbine arrays that have a 30% capacity factor. This is the same approach taken in Kilcher et al. (2021). Tidal resources in Alaska are shown in **Table 5**. Only BOEM OCS Planning Areas with OCS tidal resources modeled by Haas et al. (2011) are included.

Table 5. Technical capacity of tidal resources in Alaska’s OCS

BOEM Planning Area	Channel Name	Channel Width (km)	Average Depth (m)	Max Depth (m)	Technical Resource (TWh/yr)*	Technical Capacity (GW)**
Gulf of Alaska					99.81	37.98
	Clarence Strait	10.2	301.2	415.2	17.98	6.84
	NE of Warren Island	3.4	86.6	119.6	2.34	0.89
	Summer Strait	19.8	132.2	251.5	11.68	4.45
	Chatham Strait	16.7	503.1	736.2	52.73	20.06
	Peril Strait	1.8	5.4	6.4	0.46	0.17
	S of Inian Islands	1.7	41.6	61.2	1.20	0.46
	Inian Islands	0.8	39.7	39.7	0.74	0.28
	N of Inian Islands	5.1	133.3	232.6	11.23	4.27
	Between Wingham and Kanak Islands	4.6	5.8	11.7	0.32	0.12
Cook Inlet					78.89	30.40
	Cook Inlet	93.8	127.9	160.5	79.89	30.40
Kodiak					6.27	2.39
	N of Whale Island	0.7	14.5	14.5	0.37	0.14
	S of Whale Island	1.0	24.9	32.7	0.96	0.37
	Russian Harbor	2.2	20.6	32.6	0.72	0.27
	Between Sundstrom and Sitkinak Islands	7.4	20.4	45.5	2.75	1.05
	Between Sitkinak and Tugidak Islands	6.1	4.2	6.7	1.43	0.54
Aleutian Arc					19.97	7.60
	Avatanak Strait	5.8	54.4	94.5	1.10	0.42
	Ugamak Strait	6.8	41.5	69.9	0.82	0.31
	Derbin Strait	3.0	40.3	80.7	0.43	0.17
	Akutan Pass	3.7	37.6	46.6	0.50	0.19
	Unalga Pass	3.0	34.8	49.5	0.33	0.13
	Umnak Pass	5.9	48.8	63.7	1.20	0.46

BOEM Planning Area	Channel Name	Channel Width (km)	Average Depth (m)	Max Depth (m)	Technical Resource (TWh/yr)*	Technical Capacity (GW)**
	Between Uliaga and Kagamil Islands	5.9	54.2	69.1	0.88	0.34
	Between Carlisle and Chuginadak Islands	2.3	31.9	52.1	0.36	0.14
	Between Seguam and Amlia Islands	26.8	94.6	175.6	5.12	1.95
	Between Oglodak and Atka Islands	7.0	32.6	43.9	1.19	0.45
	Between Fenimore and Iकिनak Islands	7.4	30.2	44.3	1.08	0.41
	Between Chugul and Tagalak Islands	2.8	29.6	40.5	0.29	0.11
	Between Igitkin and Chugul Islands	2.1	32.4	45.0	0.33	0.13
	Between Igitkin and Great Sitkin Islands	2.6	55.2	76.3	0.52	0.20
	Between Little Tanaga and Kagalaska Islands	2.3	36.0	45.2	0.28	0.11
	Between Kagalaska and Adak Islands	8.7	57.1	71.0	1.86	0.71
	Between Tanaga and Kanaga Islands	7.6	24.8	43.3	0.60	0.23
	Between Unalga and Kavalga Islands	11.8	48.0	69.6	1.91	0.73
North Aleutian Basin					1.84	0.70
	Upper Kvichak Bay	9.2	2.8	4.5	0.87	0.33
	S of Dillingham	1.9	6.9	8.9	0.60	0.23

*Locations with theoretical resource greater than 1 terawatt-hour per year (TWh/yr) are labeled on the tidal resource maps shown in Section 3.3

**The technical capacity only includes channels greater than 100 MW.

3 Market Assessment

Alaska has more than 720,000 residents dispersed over 360 communities (**Figure 2**), with nearly half of its residents residing in the communities of Anchorage, Fairbanks, Kenai Peninsula Borough, Palmer, Wasilla and Juneau (State of Alaska 2022).

In 2020, total energy consumption⁷ in Alaska was ~640 trillion British thermal units (BTU) (U.S. Energy Information Administration [EIA] 2022a)—the eleventh lowest consumption by state in the United States. However, due to the dispersed population and cold climate, Alaska ranked second in per capita energy consumption. Natural gas is the primary source for energy in Alaska (**Figure 3**), much of which goes to power crude oil and natural gas production operations (EIA 2023a). Jet fuel ranks second in energy resource consumption, followed by distillate fuel oil (diesel fuels and fuel oils) for transportation and rural electricity generation. This is also illustrated in **Figure 4**, which shows that the industrial and transportation sectors are the prominent energy users in Alaska (EIA 2022b).

⁷ Note that energy units are reported in different ways depending on the source. Residential electricity use is generally reported in units of kilowatt-hours (kWh) or 1,000 watts usage over an hour. Electricity that is sold commercially is usually reported in megawatt-hours (MWh); 1,000 kWh is equal to 1 MWh. Similarly, bulk electricity that is reported statewide or in larger quantities is often reported in gigawatt-hours; 1,000 MWh is equal to 1 GWh. Energy is also reported in British thermal units (BTU). This is more common when reporting the energy from fossil fuels because it relates to the energy that is released when the fuel is burned; 1 kWh is equal to about 3,412 BTU. We prefer the units of electricity because most energy end use is moving toward electrification.

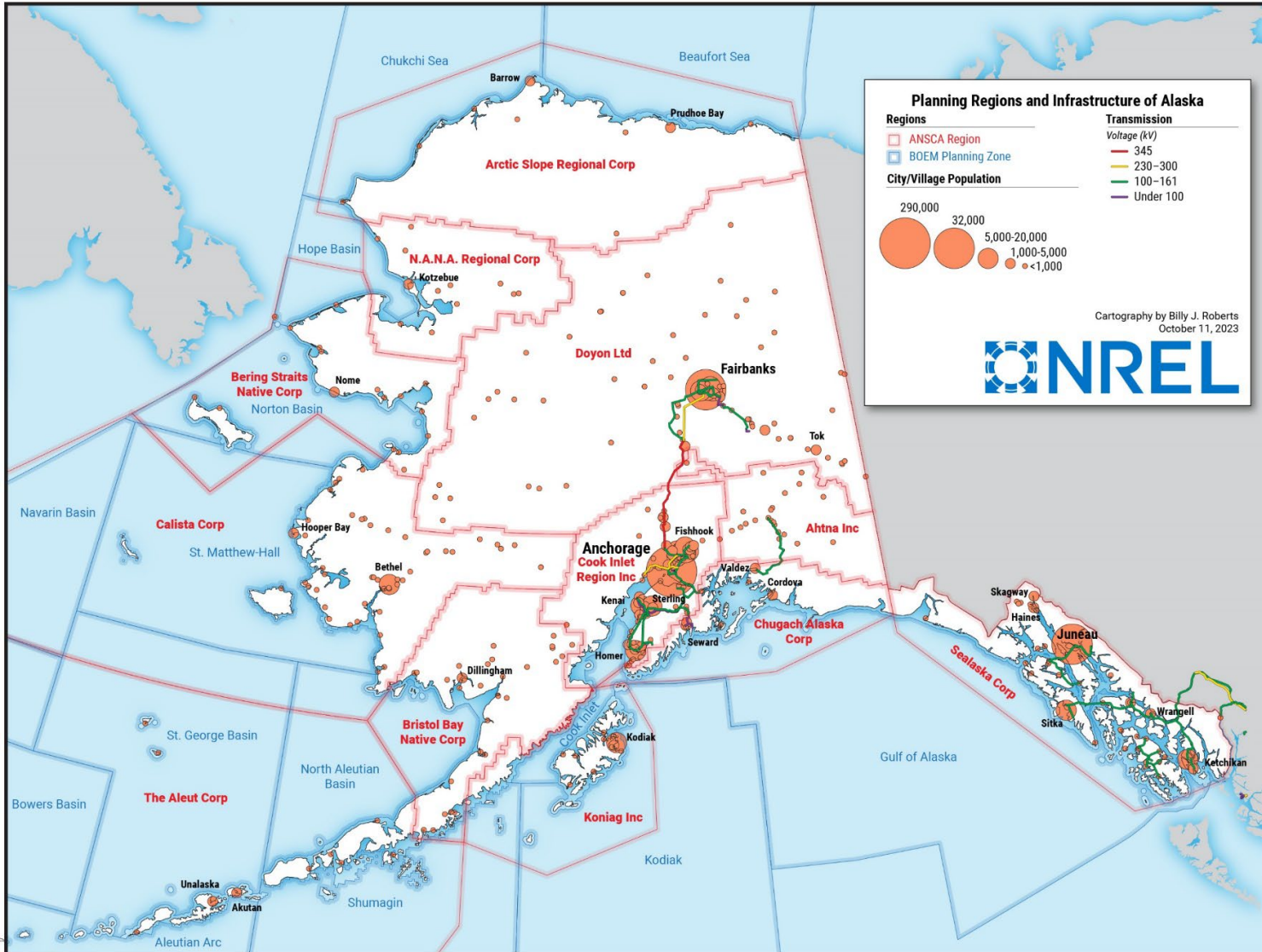

Figure 2. Population, planning regions, and infrastructure of Alaska
Illustration by Billy J. Roberts, NREL

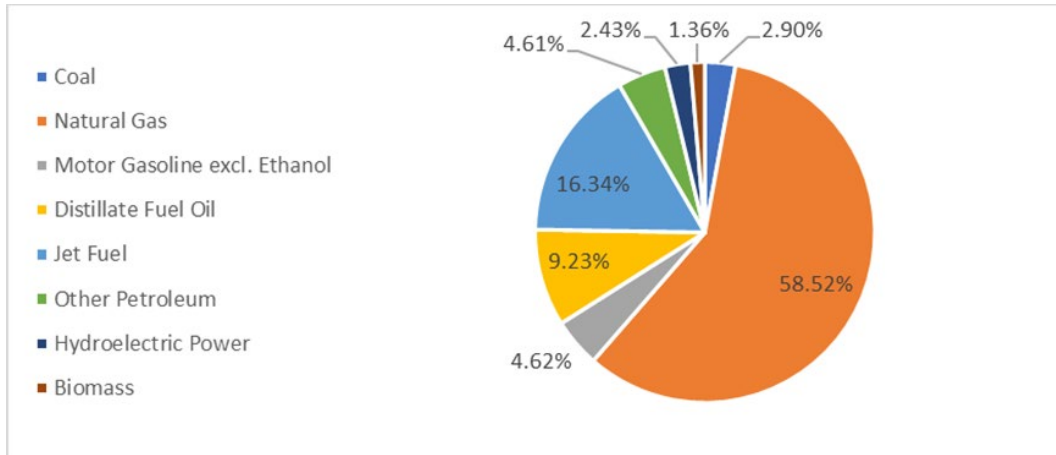

Figure 3. Total energy use in Alaska by source, 2020
Data from EIA (2022b)

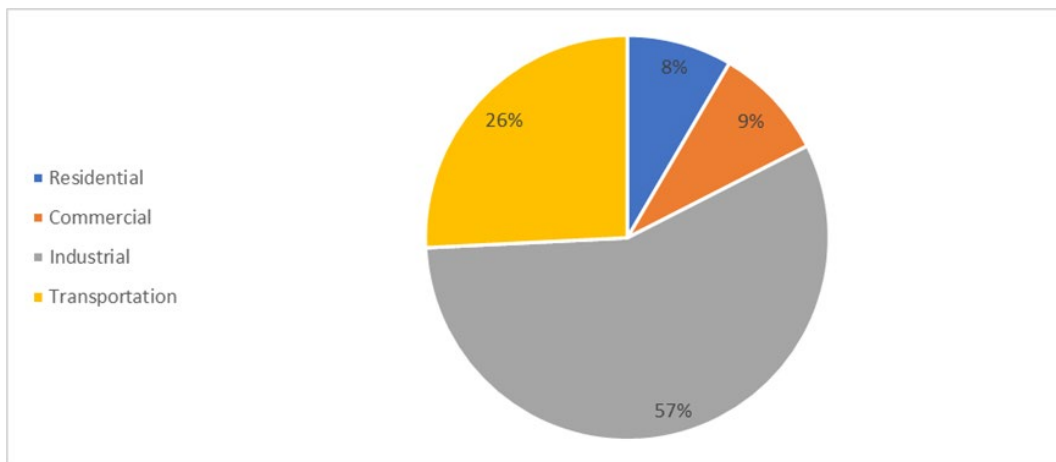

Figure 4. Total energy use in Alaska by sector, 2020
Data from EIA (2022b)

3.1 Electricity Use in Alaska

Approximately 8.6% of this total energy can be attributed to electric power generation. Approximately 30% of that electricity comes from renewable sources, predominantly hydropower and a small fraction from land-based wind energy and biomass (see the 2021 column in Table 5 in [EIA 2022a]). The remaining generation comes from fossil fuel sources (**Figure 5**). After accounting for conversion losses, this results in a statewide electricity consumption of about 5,900 GWh, which is a small fraction of the total energy consumed by the state.

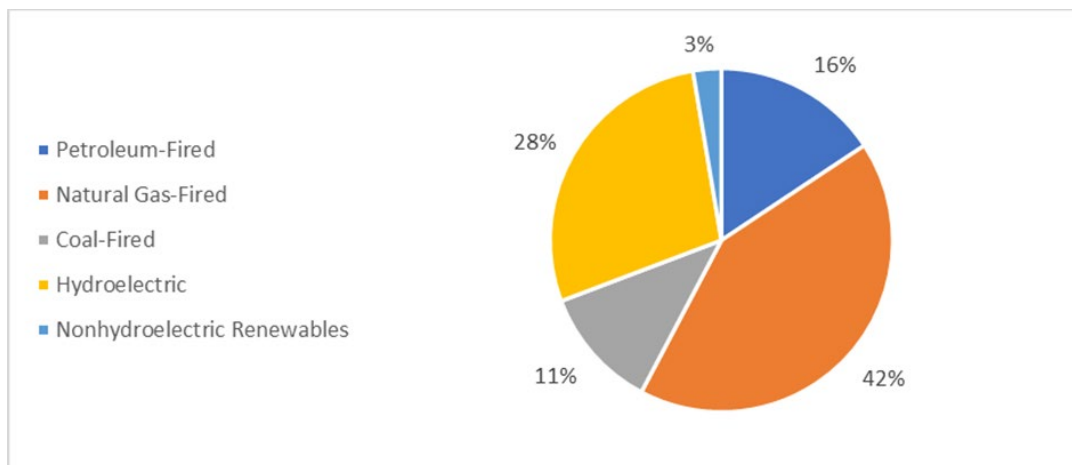

Figure 5. Net electricity generation in Alaska by source, 2020

Data from EIA (2022b)

Data for electricity consumption and cost are intermittent for communities outside of the Railbelt and rural communities that receive PCE. **Table 6** summarizes electricity statistics by large regions.

Table 6. Annual Alaska electricity consumption, rates, and primary source by region, 2019–2020

Region	Number of Communities	Electricity Consumption (GWh)	Average Residential Effective Rates (\$/kWh)	Primary Generation Source
Rural PCE Communities*	194	475	\$0.28**	Diesel
Railbelt†	92	4,407	\$0.20	Natural gas
Southeast and Other‡	74	~1,000	\$0.11–\$0.27	Hydropower
Total	360	5,882		

*2020 utility statistics data provided by Alaska Energy Authority.

**Average rate that residents pay for the first 500 kWh after Power Cost Equalization (PCE) incentive.

†Data are for 2020 and from EIA Form 861.

‡ Data from former Alaska Energy Data Gateway.

The average price for electricity in 2020 for residential customers located in the Railbelt was \$0.20 per kilowatt-hour (kWh). The least expensive power is in Southeast Alaska (region including over 20 communities from Yakutat to Metlakatla), where more than 95% of the electricity comes from hydropower (McDowell Group 2016). Rural communities have the highest cost of electricity, supplied primarily by diesel fuel.

3.1.1 Rural Power Cost Equalization Communities

There are approximately 200 stand-alone networks for electricity delivery, referred to as grids, serving rural Alaska villages where the cost of electricity can be up to 4 times more than for grid-connected communities due to the reliance on diesel generation and the cost of transport of diesel fuel to remote locations (Allen et al. 2016).

The State of Alaska’s Power Cost Equalization (PCE) Program subsidizes electricity prices for utilities serving rural communities if diesel-fired generation accounts for more than 75% of total electric consumption. The PCE reimbursement is based on a formula that includes the cost and amount of diesel

fuel required by electric consumption. In 2019, 194 communities participated in the PCE program (Alaska Energy Authority 2019).

In 2019–2020, annual electricity generation sold and consumed in rural PCE communities was 475 GWh, 89% of which came from diesel fuel (**Figure 6**).

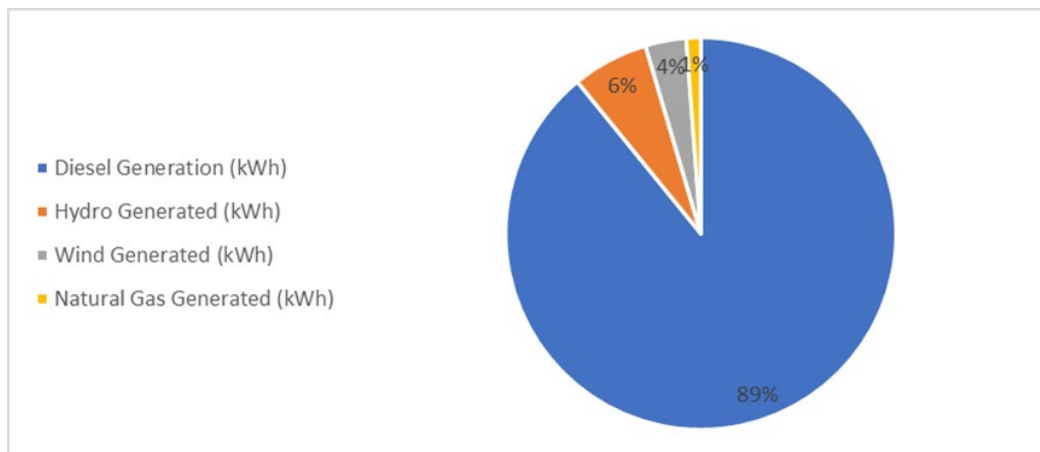

Figure 6. Electricity generation mix for rural PCE communities, July 2019–June 2020
Unpublished data provided to NREL by Alaska Energy Authority in 2021

Electricity consumption by rural PCE community ranged from 50 megawatt-hours (MWh) to 53,600 MWh, with a median usage of 852 MWh. Communities with annual electricity generation of more than 5,000 MWh are listed in **Table 7**. Even with the PCE, residential rates are still more than double those of the Railbelt or Southeast Alaska regions and exceed \$0.70/kWh in some communities (included in unpublished data provided to NREL by the Alaska Energy Authority in 2021). Communities often use more diesel fuel for heating than for electricity and pay a premium for fuel to be flown or shipped in and stored in bulk storage tanks. Additional costs associated with maintaining the storage tanks are often not included when considering the cost effectiveness of renewable energy alternatives.

Table 7. Annual electricity generation in large, rural communities, July 2019–June 2020

Community Name	Total Generation (kWh)	Fuel Used (gallons)	Peak Consumption (kW)
Unalaska (Dutch Harbor)	53,613,027	3,804,165	12,489
Bethel; Oscarville	44,330,425	3,101,629	-
Nome	31,561,658	1,868,237	5,137
Naknek	26,290,460	1,758,588	13,335
Cordova	24,300,439	655,347	8,761
Kotzebue	19,919,319	1,227,703	3,489
Dillingham; Aleknagik	19,300,221	1,292,226	6,050
Tok; Tanacross	9,747,320	677,763	1,721
Wainwright	7,587,940	559,197	1,354
Nuiqsut	7,131,428	180,124	1,482
Yakutat	5,974,703	411,215	-

Unpublished data provided to NREL by Alaska Energy Authority in 2021

More rural communities use hydropower, wind energy, and solar energy projects to offset the high and volatile cost of diesel fuel. Maintenance support and training remain key to the success of renewable energy projects in remote areas to prevent stranded generation assets. The PCE program, which provides reimbursement to rural utilities based on the cost and usage of diesel fuel, also mitigates the high cost of energy in rural Alaska (About the Power ... c2023). It should be noted that there has been discussion at the state level on expanding the energy grid to outlying communities (which could in turn make renewable energy projects more attractive to smaller communities). A 2012 report entitled *Energy for a Sustainable Alaska – The Rural Conundrum* (Kohler and Schutt 2012) advocates that “strategically placed roads and transmission lines can play an important role in decreasing the capital, operations, and maintenance costs associated with energy development in rural Alaska.” The report suggests that interties could be economical for communities within 20 miles of each other (Kohler and Schutt 2012).

When a community utility installs a renewable energy system to reduce diesel generator fuel usage, the PCE reimbursement to the utility is also reduced. Some communities are investigating if community-based independent power producer ownership options can preserve the PCE payments and result in additional benefit flows that are equivalent to reduced PCE rates to the residential and community-based electric customers. There are communities that already have community-based independent power producer ownership in place.

3.1.2 Railbelt

The Railbelt grid (**Figure 7**) runs north-south from Fairbanks through Anchorage to the Kenai Peninsula and represents ~75% of Alaska’s electric load.

All five utilities serving Railbelt communities are interconnected but can operate independently as needed to provide backup power during transmission outages. Electricity sales in 2020 totaled 4,407 GWh with a combined system capacity of 1,826 MW, approximately 1,075 MW higher than the 2018 peak demand of 751 MW. This equates to a reserve margin of about 143% (**Table 8**; Denholm et al. 2022).

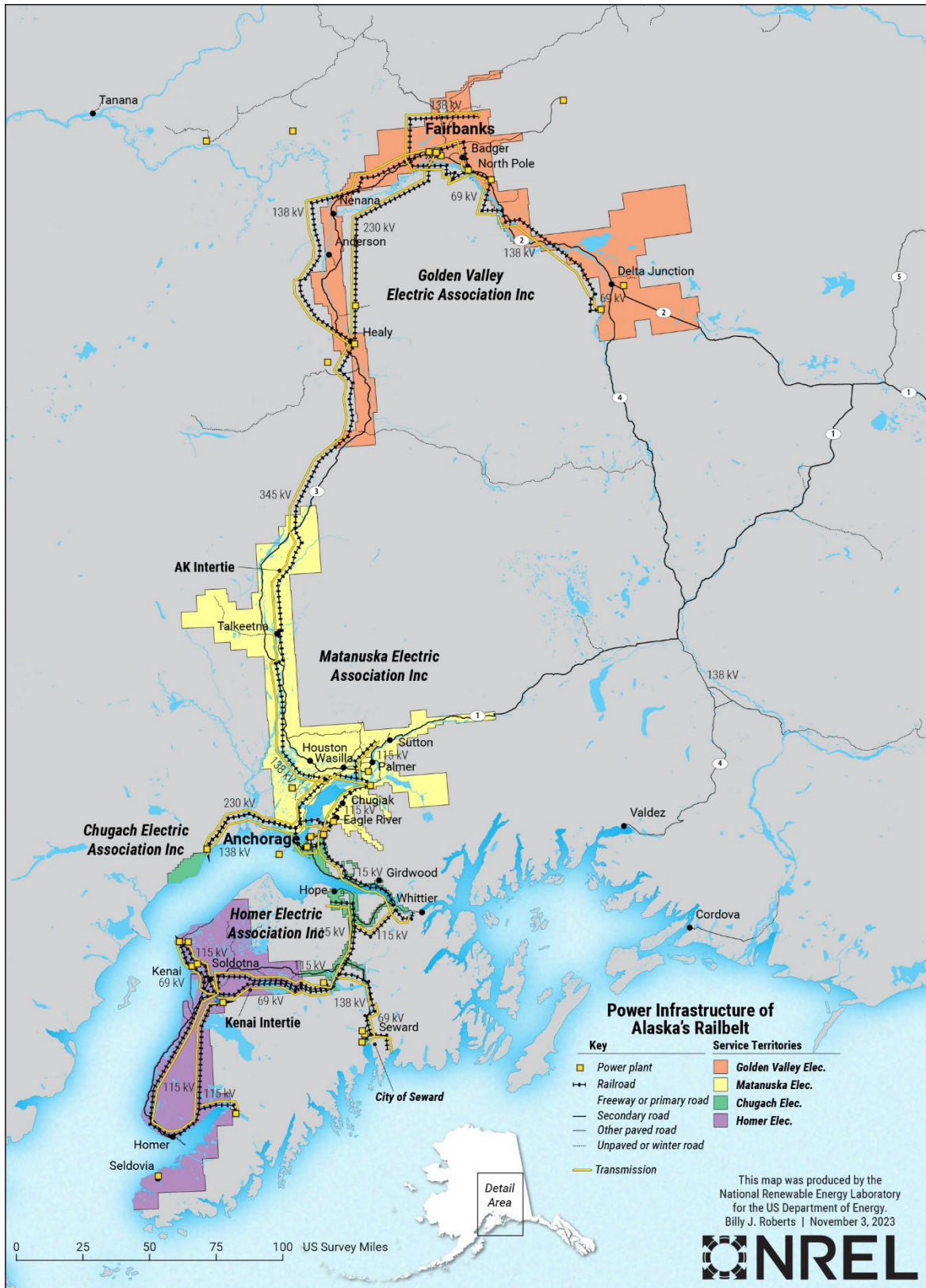

Figure 7. Power infrastructure of Alaska's Railbelt Grid
 Illustration by Billy J. Roberts, NREL

Table 8. Railbelt electricity sales and rate by utility in 2020

Utility	Electricity Sales (GWh)	Fraction of Railbelt Demand (%)
Chugach Electric Association	1,945	44
Golden Valley Electric Association	1,222	28
Matanuska Electric Association	751	17
Homer Electric Association	437	10
City of Seward Electric Department	52	1
Total	4,407	100

Data from Denholm et al. (2022)

Approximately two-thirds of the Railbelt grid runs on natural gas supplied from the Cook Inlet basin (**Figure 8**). Currently, approximately 20% of Railbelt electricity generation is from renewable sources, primarily hydropower. Heating needs are met by the ENSTAR Natural Gas Company, which moves gas from the Cook Inlet via pipelines. Studies show that the natural gas supply in Cook Inlet is dwindling, with potential shortages predicted within the next five years, prompting the search for alternative sources for electricity generation and heating (Cook Inlet Gas ... c2023).

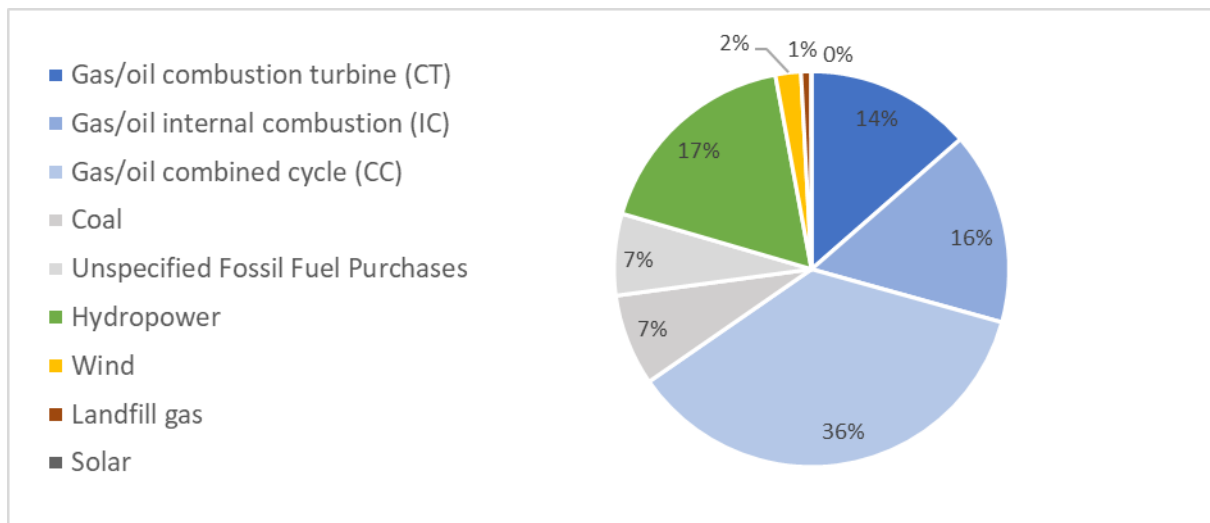

Figure 8. Electricity generation mix for Railbelt communities, 2020

Data from Denholm et al. (2022)

In December 2021, Alaska Governor Michael Dunleavy requested support from NREL to analyze the potential impacts of achieving an 80% renewable energy portfolio standard on Alaska’s Railbelt. There were two overall findings of the analysis (Denholm et al. 2022):

1. Multiple pathways exist for achieving an 80% renewable energy portfolio standard while balancing supply and demand under major outage conditions with appropriate system engineering.
2. An 80% renewable energy portfolio standard achieves a substantial reduction in existing and future fossil generator fuel costs, which could be compared to renewable energy capital cost expenditures for a comprehensive impact assessment, which could make renewable energy options more economically viable.

It was also determined that upgrades will most likely need to take place regardless of whether renewables are placed on the grid. Upgrades include but are not limited to redundant transmission lines and mitigation of existing bottlenecks at the Kenai and Alaska interties.

This renewable portfolio standards (RPS) analysis continues through 2023 as a follow-on to this work. Where the original study examined operational implications of an 80% RPS, this follow-on work analyzes the differences in costs across different scenarios.

3.1.3 Southeast and Other Communities

Electricity consumption and cost data are intermittent for communities outside of the Railbelt and rural communities that receive PCE. **Table 9** summarizes existing data for the remaining large population and load centers.

Table 9. Annual Alaska electricity consumption, rates, and primary source for non-PCE communities in the southeast and other regions

Alaska Energy Authority Energy Region	Number of Communities	Net Yearly Electricity Generation (GWh)*	Average Residential Effective Rates (\$/kWh)**	Primary Generation Source**
North Slope	1	48	\$0.17	Natural gas
Copper River/Chugach	14	87	\$0.27	Hydropower
Kodiak	5	149	\$0.18	Hydropower and Wind
Southeast	6	843	\$0.11–\$0.17	Hydropower

*Source: (Electricity rates ... 2022)

**Data from former Alaska Energy Data Gateway

The largest electric demand in the remaining regions resides in the southeast (region including more than 20 communities from Yakutat to Metlakatla), where 95% of the electricity generation is from hydropower. Challenges for communities served by hydropower in Southeast Alaska include finding methods to capture excess spillover in the summer months to cover the load during the low-flow months in the winter. Additionally, some communities struggle with increased drought conditions and rely on diesel generation for backup power and to preserve drinking water. Load growth is also expected in some of the larger communities for increased adoption of heat pumps and electric vehicles as well as the expansion of shore power for berthed cruise ships.

3.2 Additional Marine Renewable Energy Supply Opportunities

3.2.1 Decarbonizing Energy Use

Given that only 8.6% of Alaska’s total energy goes toward the generation of electricity, decarbonization strategies for Alaska will need to include the other high-carbon/high-energy use sectors, which will likely have a large impact on the state’s energy use profile over the next few decades. **Figure 9** shows that Alaska’s largest energy consumption sectors are industrial and transportation, which account for more than 81% of the energy consumed. The industrial sector primarily uses natural gas, much of which goes to power crude oil and natural gas production operations (EIA 2023a). The transportation sector is the predominant consumer of petroleum, including jet fuel (much of which supports Alaska’s unique role in cargo transport between Asia and North America) and distillate fuel oil (much of which is used for transportation and rural electricity generation).

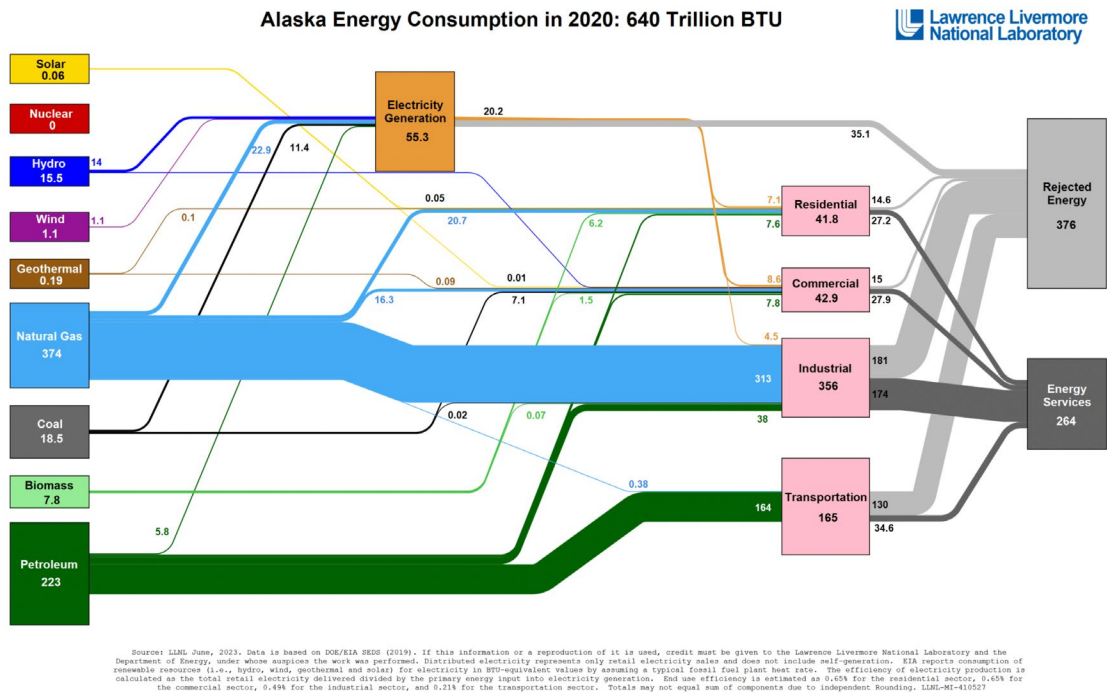

Figure 9. Alaska total energy consumption in 2020

Source: Lawrence Livermore National Laboratory (2023)

Load growth analysis performed by the University of Alaska at Fairbanks indicates that below a 90% adoption scenario for electric vehicles and residential heat pumps, the total electric load on the Railbelt will increase by 116%, with the peak electric demand increasing by 216% by 2050, assuming no significant changes in the population. (Cicilio et al. 2023). Even with this expected doubling of the Railbelt electric load, additional decarbonization strategies will be needed such as non-grid offtake mechanisms to power large industrial loads, the production of clean hydrogen, and possibly carbon capture and sequestration options for natural gas.

3.2.2 Clean Hydrogen Opportunities

Alaska is positioned to produce clean hydrogen (H₂) to support the DOE’s Hydrogen and Fuel Cell Technologies Office (HFTO) targets of 10 million metric tons (MMT) and 50 MMT H₂ capability in the United States by 2030 and 2050, respectively (DOE Office of Policy 2022). The net energy potential from ocean energy resources in Alaska could be a large contributor to meeting our nation’s clean hydrogen goals. Market opportunities⁸ that have been identified to derive this estimate pertain to (but are not limited to):

- Liquid hydrogen for ship fuel in container ships, bulk carriers, vehicle carriers, oil tankers, refrigerated and general cargo carriers, etc. (Georgeff et al. 2022).

⁸ No priority is given for one market over the other; instead, we have considered what it would look like to meet all demands simultaneously.

- Exports to Asia and Europe to meet demand per the statements in countries’ roadmaps.
- Aviation fuel to meet 185 million gallons of sustainable aviation fuels by 2026 (Alaska Airlines 2022), and by 2035 substitute the fuel requirement of 2 million gallons per day.
- Short-term storage in overground compressed hydrogen vessels or long-duration hydrogen storage in repurposed depleted gas reservoirs to ensure constant demand profiles are met.
- Future chemical industry demand and storage for power generation and resiliency.

End uses for clean hydrogen in Alaska were identified and estimated to range from 4,800 to 83,000 GWh annually. For more information on hydrogen market potential in Alaska, BOEM could consult the DOE Arctic Energy Office’s *Alaska Hydrogen Opportunities Report*, which was under production at the time of the writing of this report.

Note that there are other markets that can be an economically viable “partner” to ocean energy projects. Clean hydrogen is one example evaluated. It is recommended that other market opportunities be aggregated and evaluated as well.

3.3 Ocean Energy Resources at a Regional Level

We performed resource analysis in four distinct regions: Southcentral Alaska, Alaska Peninsula and Eastern Aleutians, Western Alaska, and Southeast Alaska. Case studies were identified in locations within three of these regions; case study descriptions and justification for their selection are provided in Section 4.

3.3.1 Southcentral Alaska

Southcentral Alaska is home to most of the state’s population, especially concentrated in and around Anchorage. The Kenai Peninsula is surrounded by Cook Inlet to the north and west, Prince William Sound to the east, and the Gulf of Alaska to the south. The Kodiak Island Archipelago lies 40 miles to the southwest, separated from the Alaska mainland by Shelikof Strait.

The highest potential offshore wind resource in Southcentral Alaska is located where Shelikof Strait and Cook Inlet connect to the Gulf of Alaska (**Figure 10**). Here, average wind speeds exceed 10 m/s at 120 m over an area of 4,688 km², and at 100 m (as shown on the map) over an area of 3,712 km², much of it in federal waters. Turnagain Arm incurs average offshore wind speeds at 120 m of up to 9.7 m/s and has the potential for offshore wind development because it is close to the Railbelt grid, may have reduced viewshed concerns, and is characterized by optimal water depths for both floating and fixed-bottom technologies. However, Turnagain Arm can be a challenging place to operate given the complex bathymetry, very high silt and sediment concentrations, and large tidal amplitudes (i.e., shallow tidal flats with narrow channels).

The wave energy resource of Southcentral Alaska (**Figure 11**) is ~80 GW but located relatively far from the Railbelt power grid compared to the tidal and offshore wind resources. This is because Cook Inlet is largely sheltered to the south by the Kodiak Archipelago from waves generated in the Pacific Ocean. The Barren Islands also help to break up wave energy that approaches from the southeast. The wave resource offshore Kodiak is greater but is located relatively far from shore compared to other sites farther west along the Aleutian chain.

The tidal energy resource of Cook Inlet (**Figure 12**) is one of the best in the world in terms of its resource availability and is the top-ranked “near-term” site for tidal energy in the U.S. according to Kilcher et al.

(2016). The Cook Inlet tides rise and fall by as much as 35 feet, which forces large volumes of water to move in and out each day. The combination of large tidal amplitudes and a large body of water means that Cook Inlet possesses approximately one-third of the nation’s tidal power resource. The most energetic location is about two-thirds the way up the inlet where the flow is “pinched”—and therefore forced to accelerate. However, there are several other locations within the inlet that have sufficiently strong currents to be viable for tidal energy development, as shown in dark orange in **Figure 12**. In federal waters, these locations are due west of Anchor Point, the Kennedy Entrance (north of the Barren Islands), and the Stevenson Entrance (south of the Barren Islands).

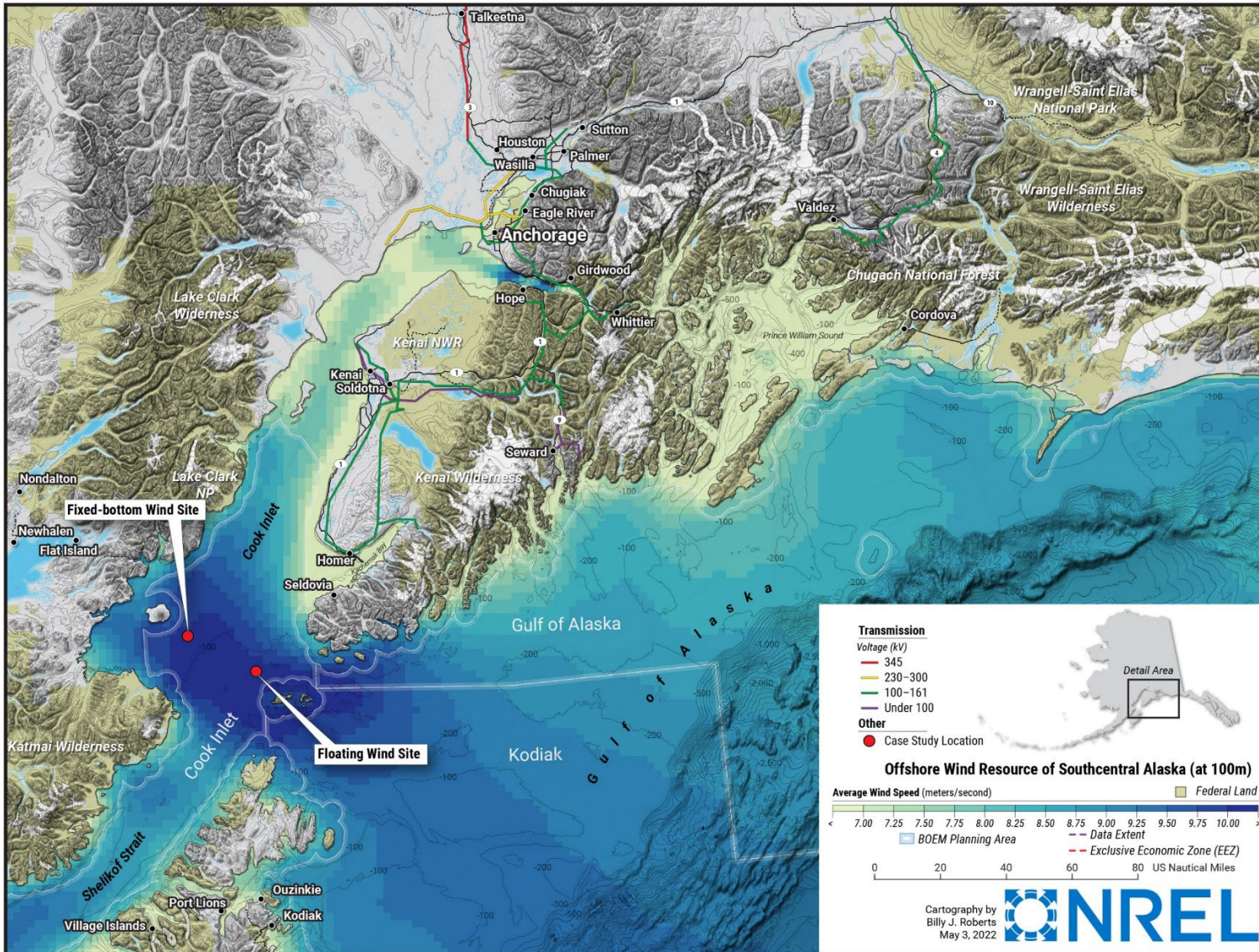

Figure 10. Simulated offshore wind energy resource of Southcentral Alaska (at 100 m)
 Case study locations are shown with red dots and labels. Illustration by Billy J. Roberts, NREL

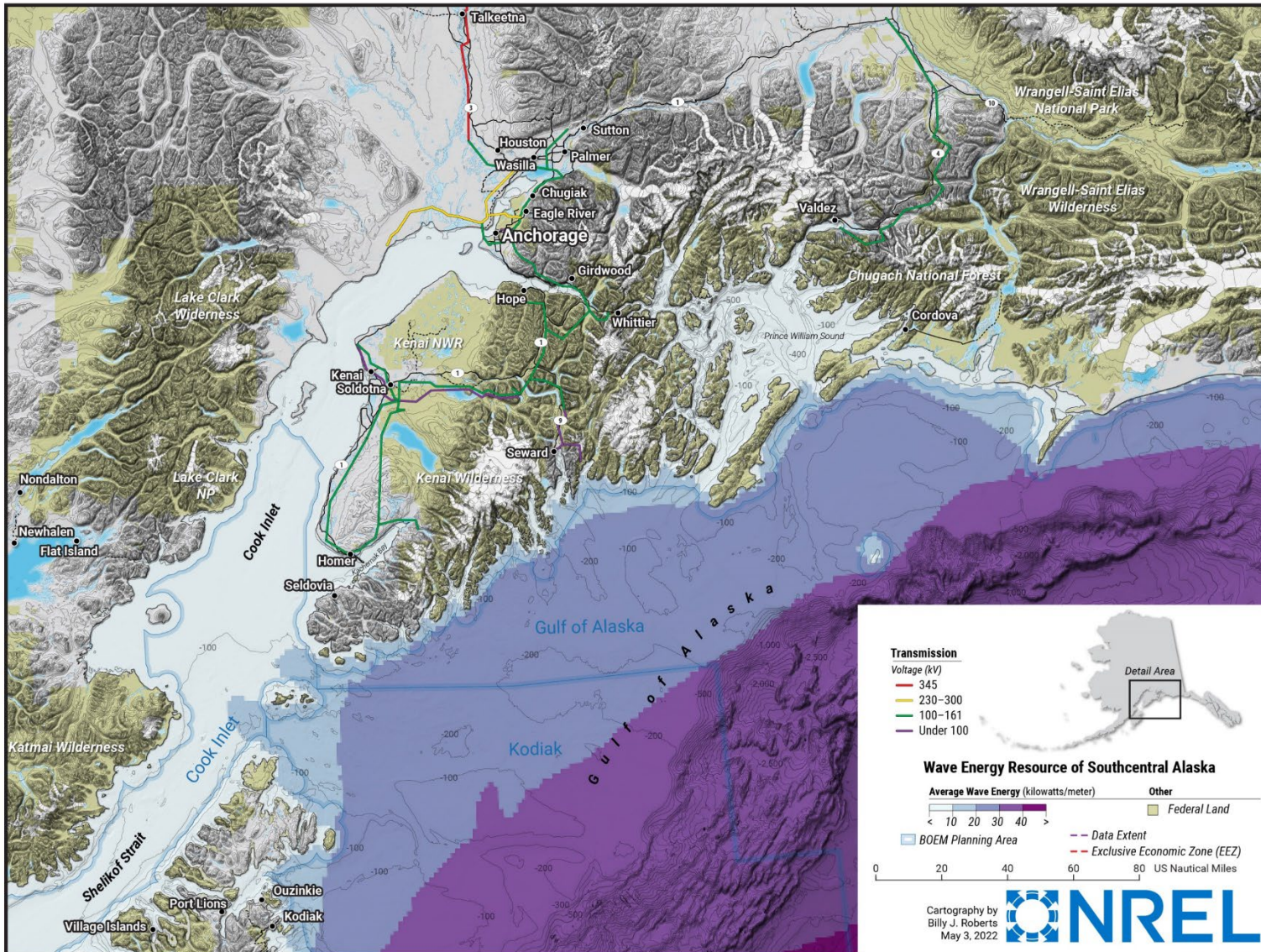

Figure 11. Simulated wave energy resource of Southcentral Alaska
 Illustration by Billy J. Roberts, NREL

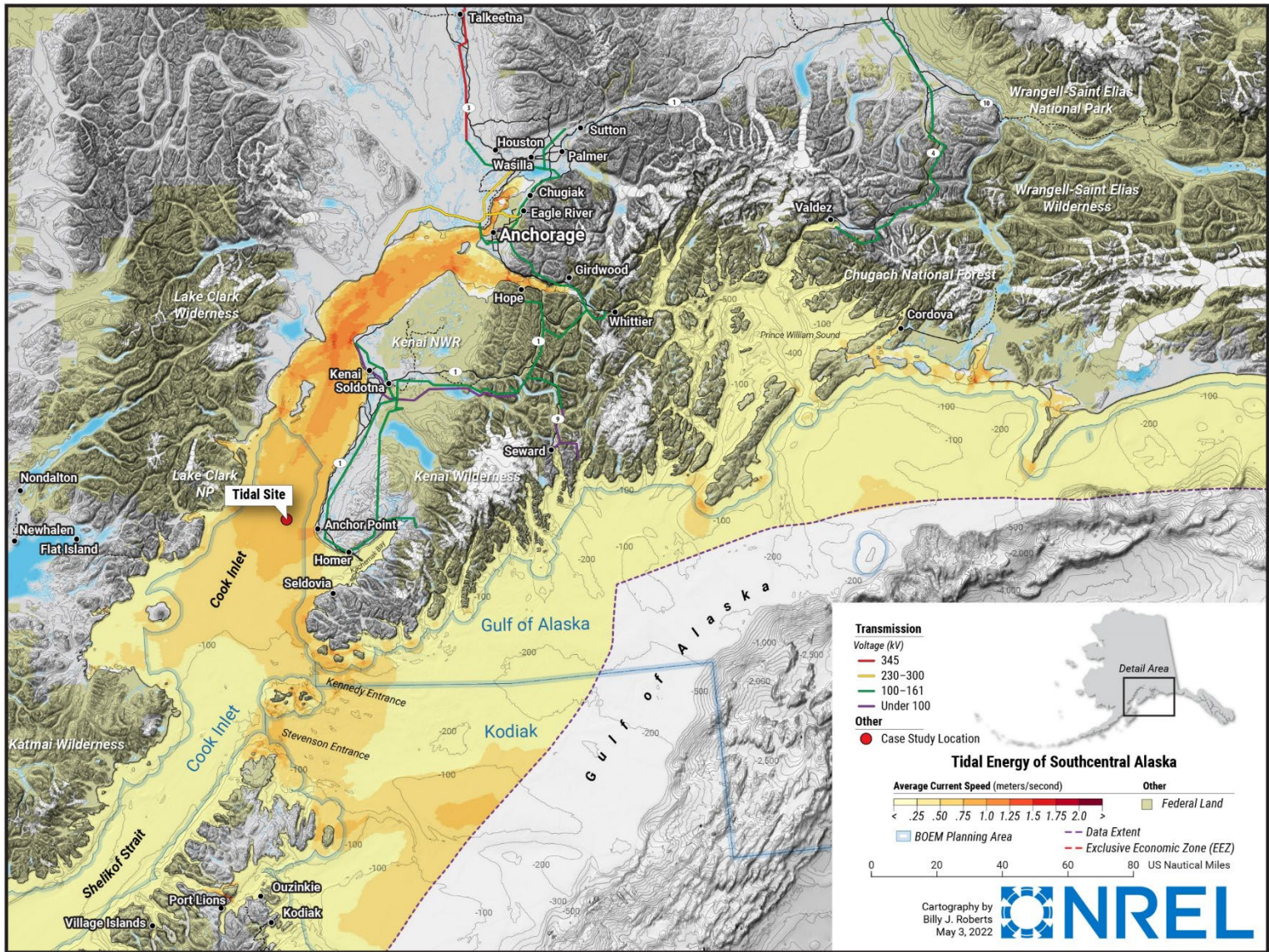

Figure 12. Simulated tidal energy resource of Southcentral Alaska
Case study shown with red dot and label. Illustration by Billy J. Roberts, NREL

3.3.2 Alaska Peninsula and Eastern Aleutians

Waters surrounding the Alaska Peninsula and the Aleutian Islands contain significant ocean energy; however, the region is sparsely populated, and there is limited industrial infrastructure. For near-term planning purposes, most of these ocean energy resources are located too far from load centers for the generated power to be used.

As demand for renewable energy continues to grow and the cost of technologies that generate and store that energy decreases, these resources may become economically viable. Because the Aleutian Islands are volcanically active, this area has potential geothermal energy resource, which could further boost the region's case for becoming a renewable energy export center. The region is positioned along existing trade routes between East Asia and the western United States (a great-circle route from Tokyo to Seattle passes to the north of the Aleutian chain). This is along the Northwest Passage—a sea lane through the Canadian Arctic Archipelago that connects the Atlantic and Pacific Oceans—which is expected to fully open in coming decades and could reduce shipping distances between East Asia and Europe by 40%.

There is a broad area at the mouth of Unalaska Bay, home to the Port of Dutch Harbor, stretching across Akutan Pass to Akutan Island, where average wind speeds are more than 9 m/s (**Figure 13**). The wave energy resource along the southern coast of Unalaska Island (**Figure 14**) is >30 kW/m within a few miles, and >40 kW/m in federal waters. Unalaska and Saint Paul are both identified as potential sites for early wave energy projects in Kilcher and Thresher (2016). Energetic tidal energy resources occur in the passes between Unalaska and Akutan Islands (**Figure 15**). West of Unalga Island, Unalga Pass lies between Akutan and Unalaska with water depths of 30–50 m, which is ideal for tidal technologies that exist today. Akutan Pass, between Unalga and Akutan Islands, is slightly deeper, wider, and farther away, which makes it promising for larger-scale tidal energy projects in the future. These sites, however, are not ideal demonstration or test sites for early technologies because they are far from infrastructure to support those kinds of projects.

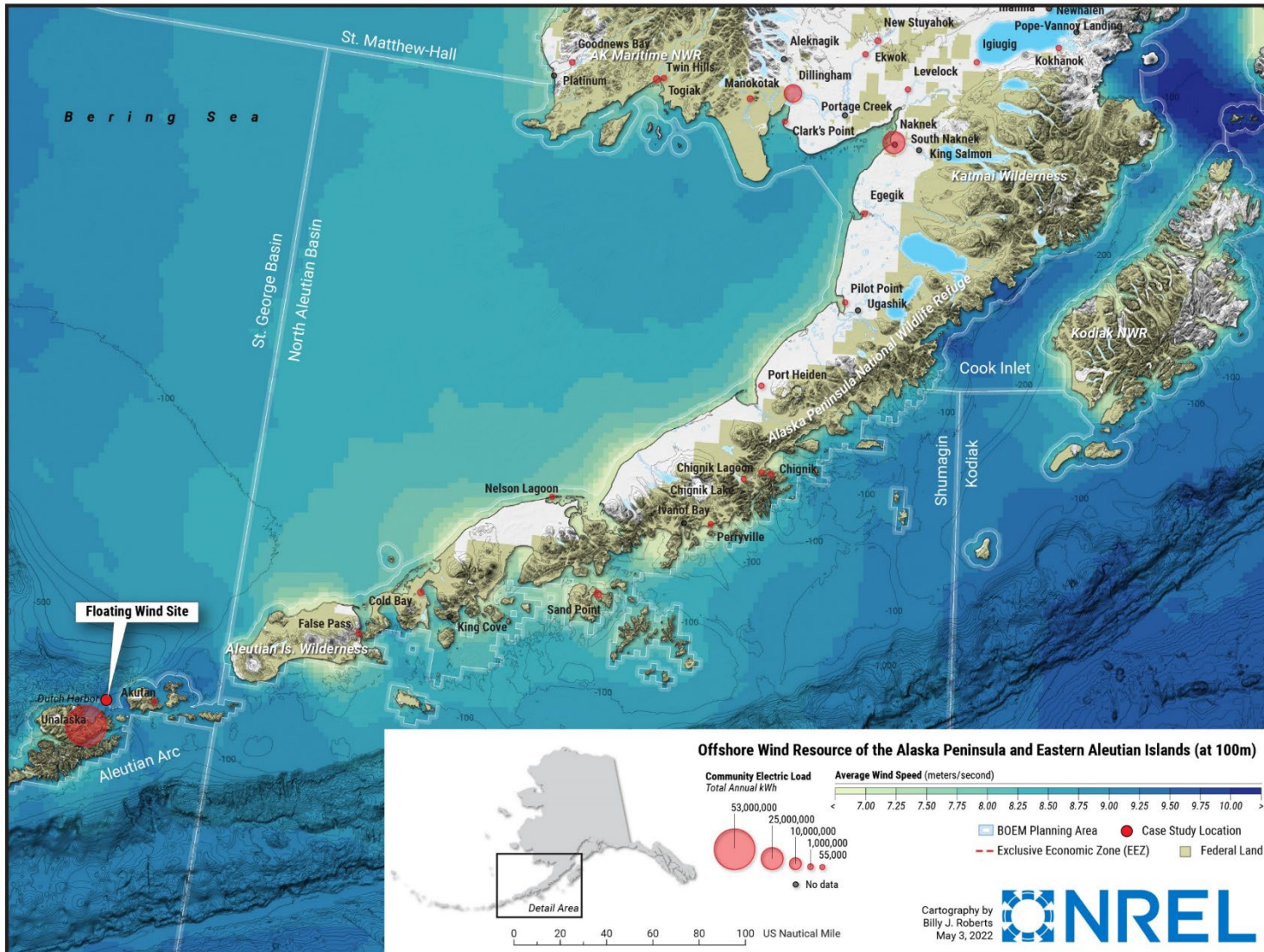

Figure 13. Simulated offshore wind energy resource of Alaska Peninsula and Eastern Aleutian Islands (at 100 m)
Case study location shown with red dot and label. Illustration by Billy J. Roberts, NREL

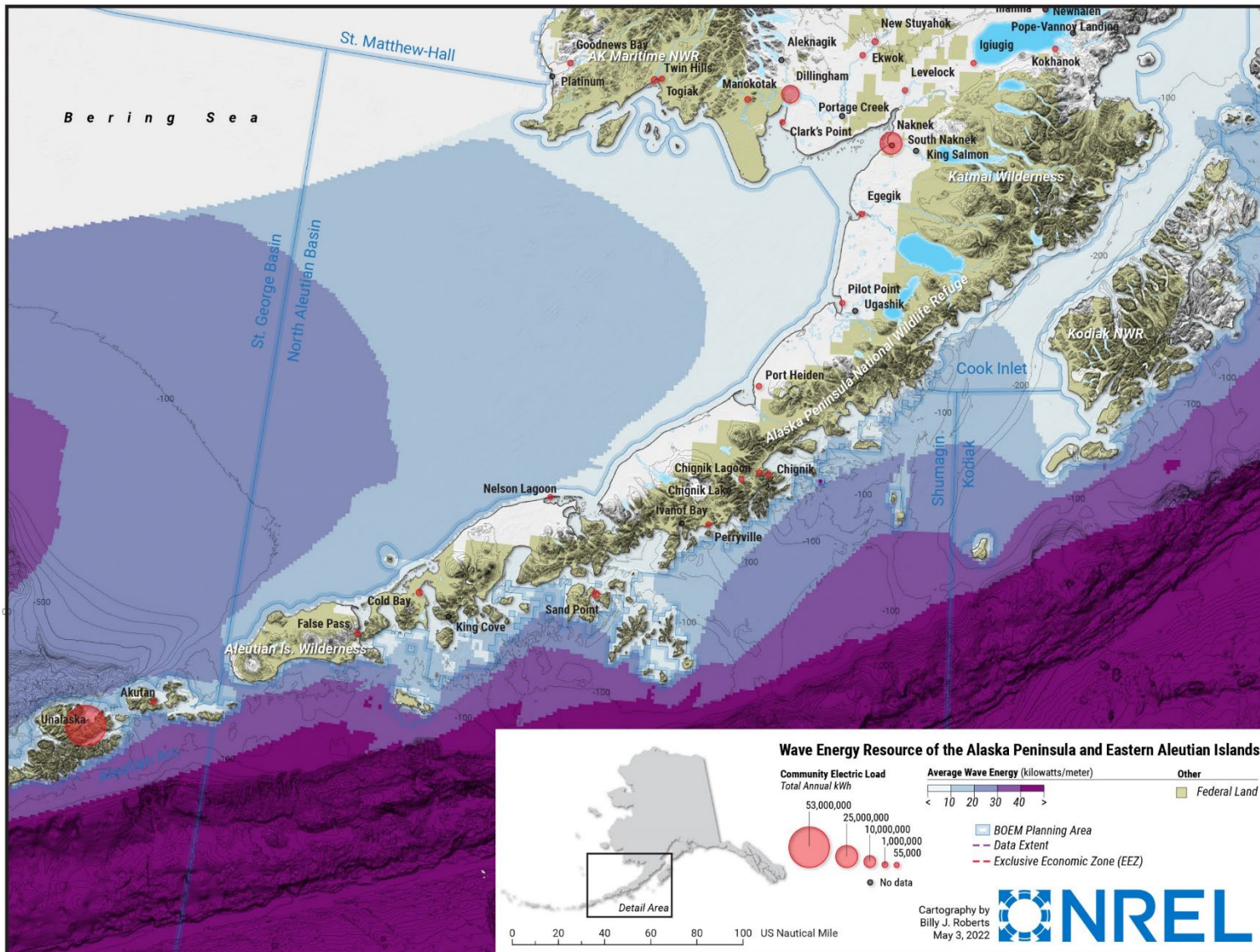

Figure 14. Simulated wave energy resource of Alaska Peninsula and Eastern Aleutian Islands
Illustration by Billy J. Roberts, NREL

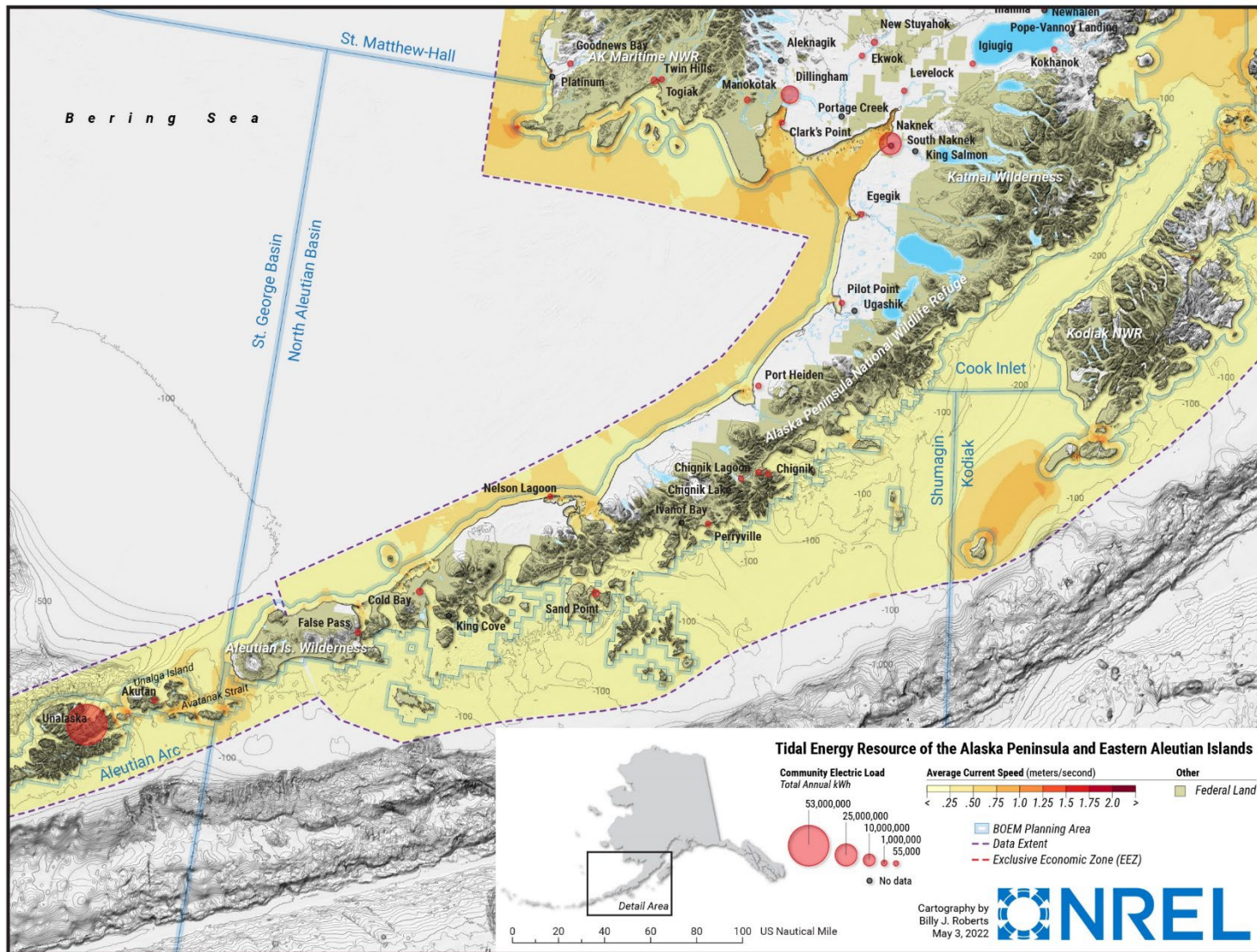

Figure 15. Simulated tidal energy resource of Alaska Peninsula and Eastern Aleutian Islands
 Illustration by Billy J. Roberts, NREL

3.3.3 Western Alaska

Western Alaska is defined here to include the Bering Strait, Seward Peninsula, the Yukon-Kuskokwim Delta, St. Lawrence Island, and Nunivak Island. The tidal and wave energy resource data currently available for this region are not sufficiently accurate for analyses because the potential effects of ice cannot be modeled. However, the offshore wind resource of the region, particularly in the Bering Strait north of St. Lawrence Island (**Figure 16**) has significant energy development potential. In addition, large portions of the Bering Sea are characterized by average winds of >9 m/s for potential hydrogen production and export.

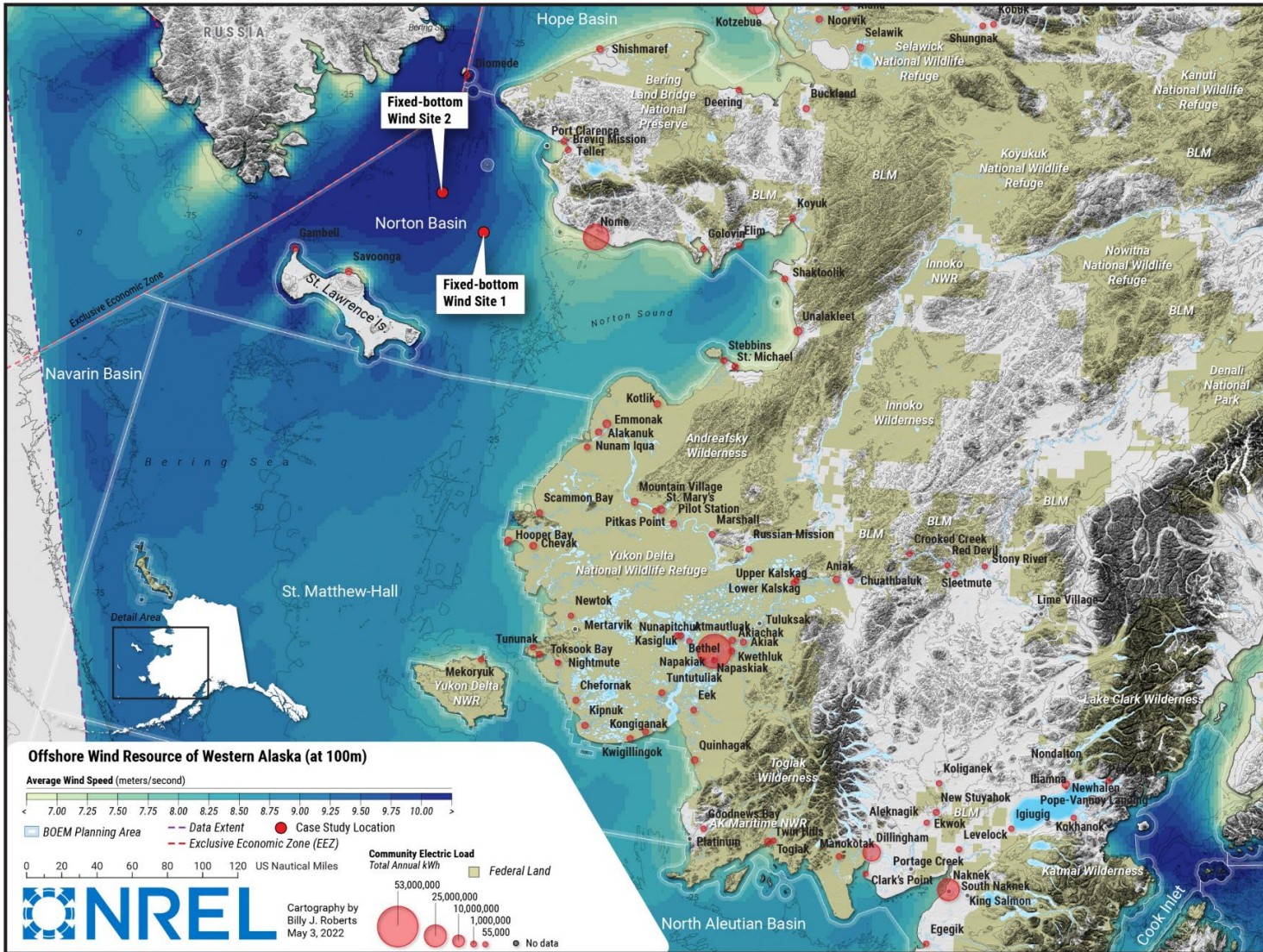

Figure 16. Simulated offshore wind energy resource of Western Alaska (at 100 m)
Case study locations shown with red dots and labels. Illustration by Billy J. Roberts, NREL

3.3.4 Southeast Alaska

The strongest winds in this region are found 10–30 nautical miles offshore of the Prince of Wales Island group (**Figure 17**); however, it is relatively far from any communities that could utilize the power. Craig, Hydaburg, and Klawock are all small communities located on inland waters where winds are much weaker (below 7 m/s on average). There is a region of moderate wind resource of >9 m/s near Annette Island at the southern tip of the state. Throughout much of the rest of the inland waters of Southeast Alaska, our data indicate that the resource is relatively small. Simulations always carry a certain degree of uncertainty that cannot be fully quantified without access to measurements. As this assessment is based on simulated data only, we recommend that the resource numbers from this report be used with the understanding that they carry an undefined degree of uncertainty. The uncertainty of the data at selected sites, albeit different from the ones assessed in this report, can be estimated from Doubrava et al. (2017) and Lee et al. (2019).

The wave energy resource of this region is among the most energetic wave fields in the country, surpassed only by the waves along the Aleutian chain. The resources are especially energetic along the southern half of the panhandle, reaching more than 40 kW/m within a few nautical miles of shore (**Figure 18**). If wave and storage technologies become sufficiently affordable in the future, these resources could become economically viable. At the northern end of this region is Yakutat, a community that has considered wave energy (Previsic and Bedard 2009) and is identified in Kilcher and Thresher (2016) as a promising early-market site. While the resource there is not quite as energetic as farther to the south, it is highly energetic (>30 kW/m) and located just a few miles from downtown Yakutat. Sitka is another community along the outer coast of Southeast Alaska that has access to the elevated wave energy resource in the region—though the resource is lower within Sitka Sound due to the islands sheltering it. Most of the other communities in Southeast Alaska are located on inland waters where the wave energy resource is small.

Southeast Alaska has potential tidal energy sites scattered among the state waters, narrow straits, and passages that shape the coastline of this archipelago. The strongest currents can be found at a site at the entrance to Glacier Bay, especially at North Inian Pass and the Northern Passage of Icy Strait (dark orange area in **Figure 19**). There are also very energetic tidal currents north of Wrangell, but most of this is in very shallow waters at the outflow of the Stikine River (**Figure 19**). This could be an opportunity for a combined tidal-river energy project, but more detailed modeling is needed to define the opportunity. To the west of Wrangell—along the northern edge of Prince of Wales Island—Sumner Strait possesses strong currents and a wide range of water depths that are likely to be ideal sites for tidal energy projects. Chatham Strait is another resource, comparable to Cook Inlet in terms of total capacity. Much of the southern section of Chatham Strait (south of Fredrick Sound) is also federal waters, which means that it may be another site for tidal energy projects. However, because the waters here are relatively deep (1,000 m or more), the current speeds are slower and mooring systems more complex. It is recommended to first attain a clearer understanding of whether tidal energy technologies are viable in shallower waters with higher speeds before locating tidal projects in federal waters of Southeast Alaska.

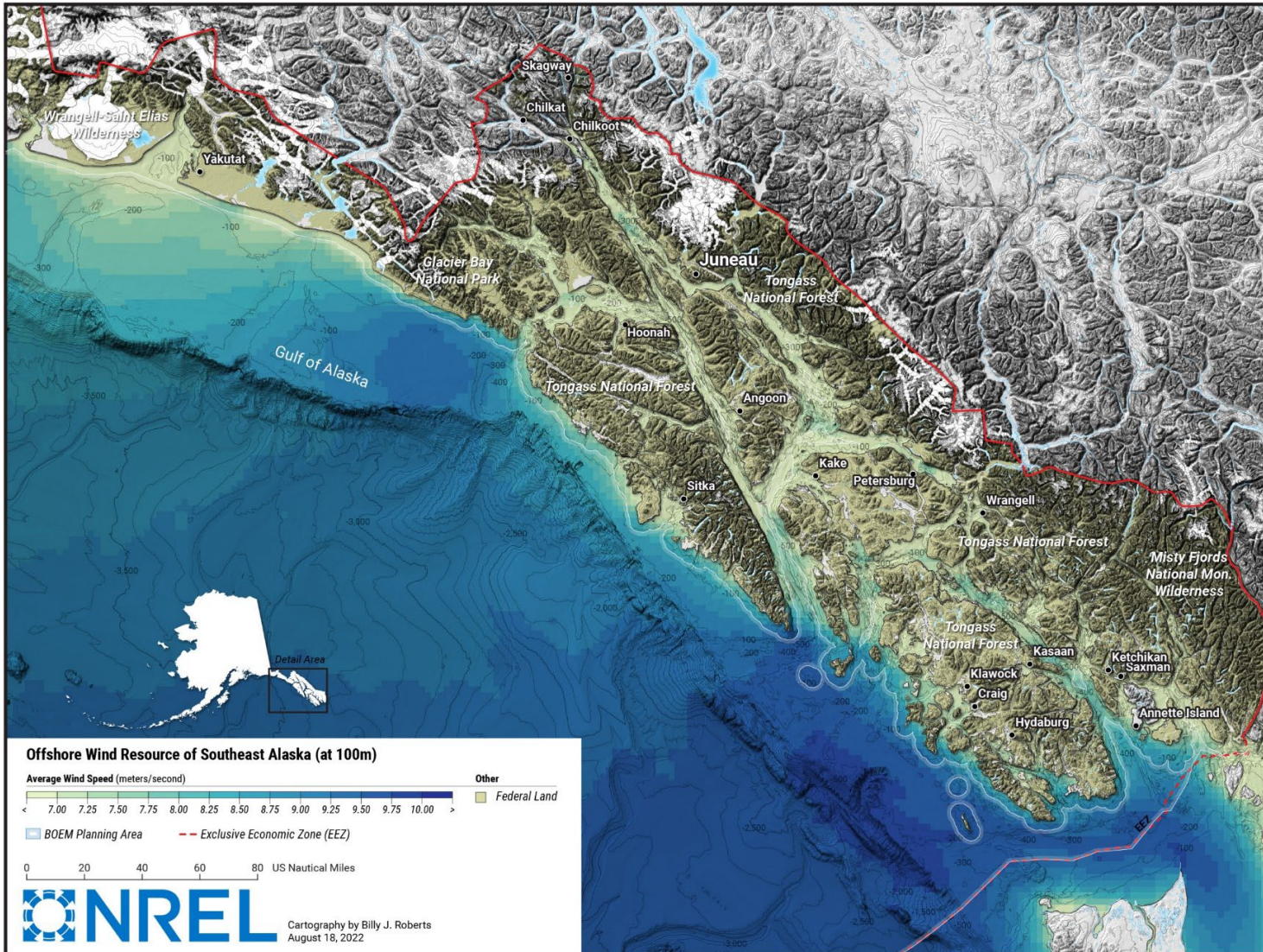

Figure 17. Simulated offshore wind energy resource of Southeast Alaska (at 100 m)
The solid red line represents the state border. Illustration by Billy J. Roberts, NREL

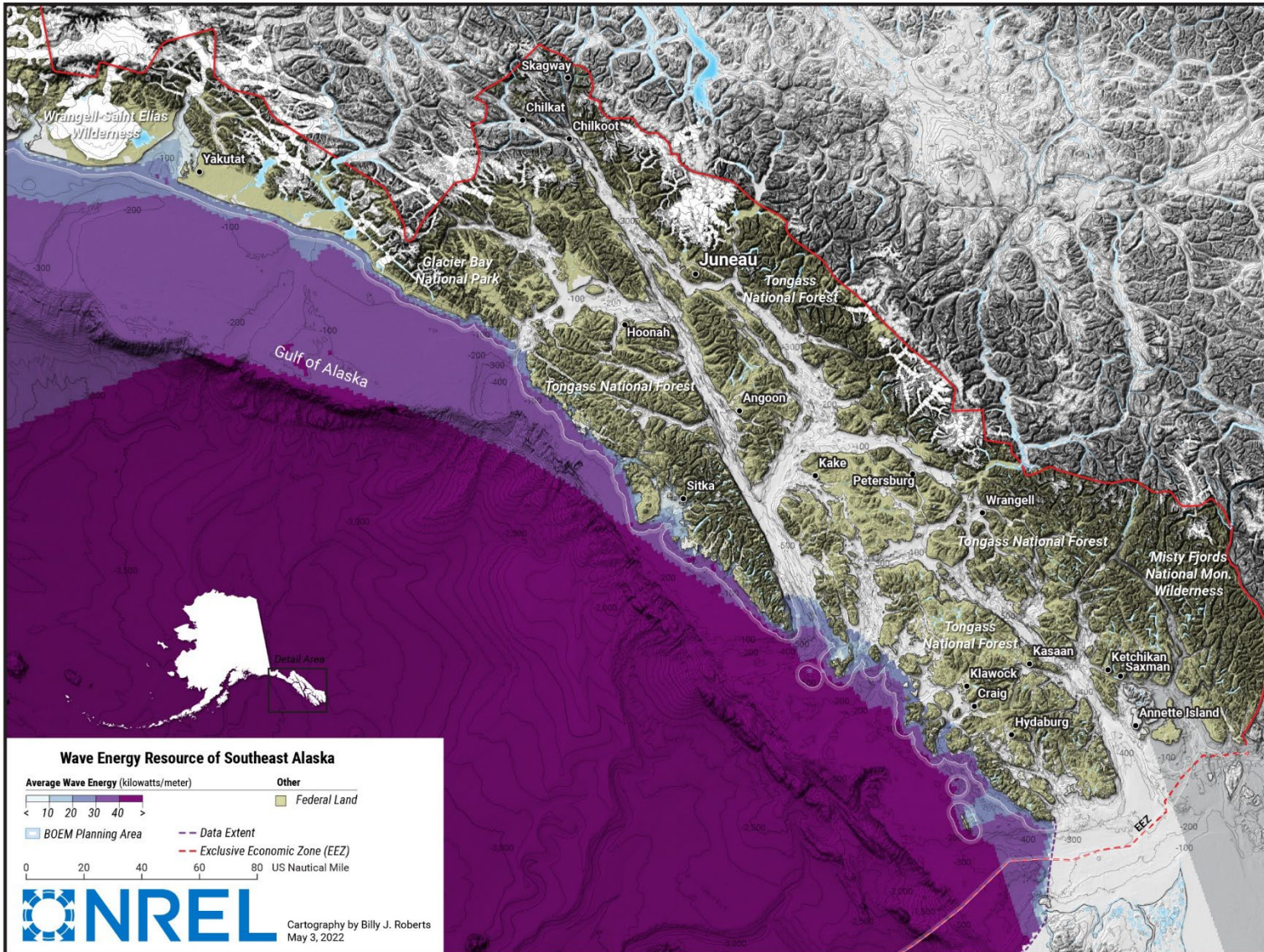

Figure 18. Simulated wave energy resource of Southeast Alaska
The solid red line represents the state border. Illustration by Billy J. Roberts, NREL

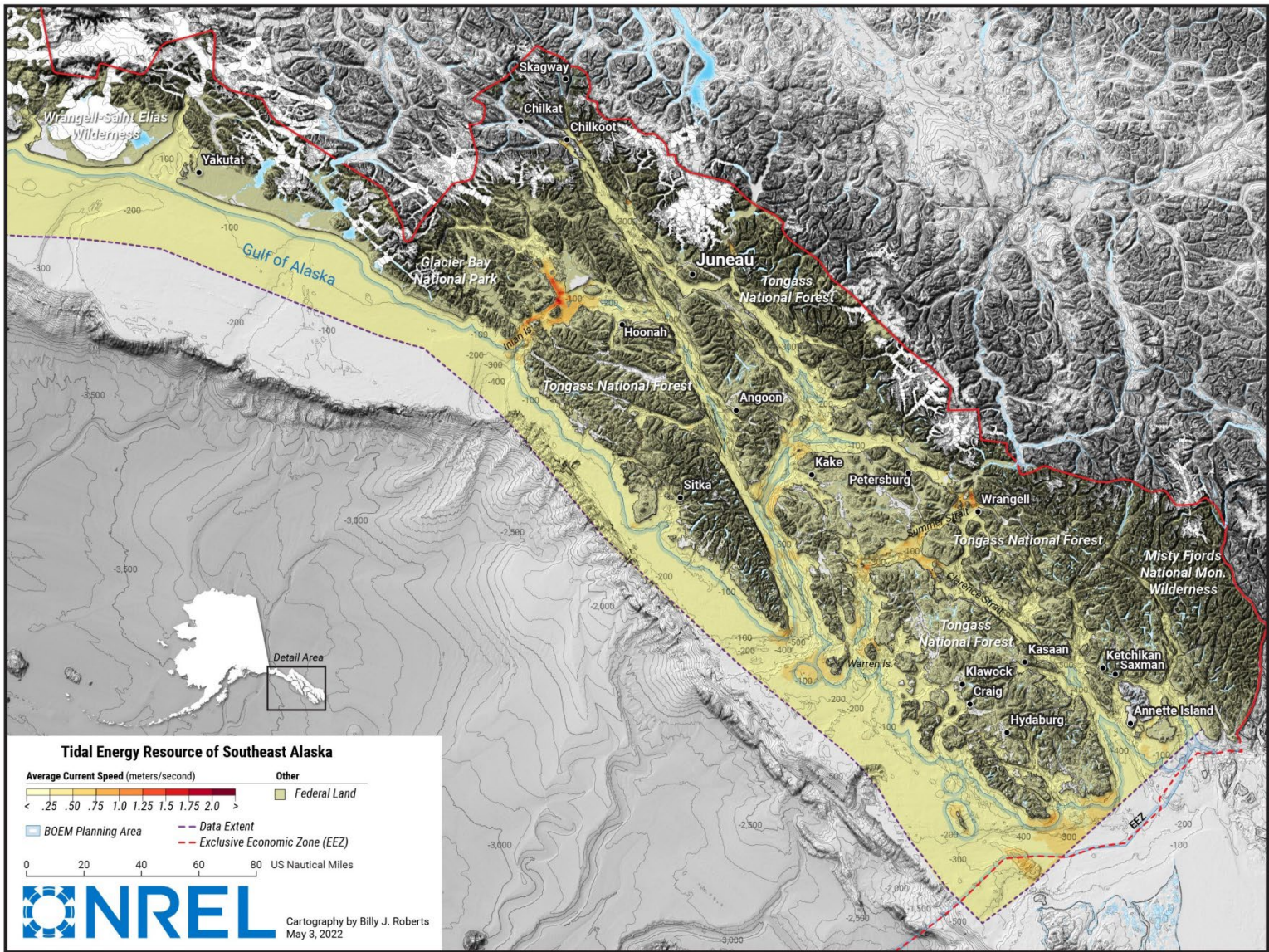

Figure 19. Simulated tidal energy resource of Southeast Alaska
 The solid red line represents the state border. Illustration by Billy J. Roberts, NREL

4 Case Studies and Analysis Performed

As indicated earlier, the ocean renewable energy resource area in Alaska is expansive, and most of these resources would not be practical to develop commercially. As such, this study focuses on techno-economic assessments for selected case studies that could potentially have the highest merit in providing ocean-based renewable power. In addition, potential hydrogen storage sites were selected in locations where ports could be expanded and where hydrogen demand could arise. General information is shared first in this section followed by case-study-specific information.

4.1 General Case Study Information

For our case studies, we only consider utility-scale projects, as pilot-scale projects are not likely to be economically viable; therefore, the case studies are various hypothetical utility-scale ocean energy projects that have sufficient ocean energy resource. In addition, as the available ocean energy resource far exceeds the electrical demand in the aforementioned regions, the assessment of an accompanying clean hydrogen market is embedded in each of the case study scenarios. This includes an assessment of varying hydrogen production markets to serve the Railbelt, rural communities, jet fuel needs, the military, fisheries, canneries, and shipping, and for export and other emerging end uses. Finally, locations were selected where there is an existing port that can be adapted to support clean hydrogen electrolysis facilities.

The case studies include a mixture of offshore wind and tidal projects in three regions representing different market opportunities for ocean energy, primarily as it relates to clean hydrogen production. We do not include wave energy in our case study analyses, as wave energy may not reach utility-scale viability in the next 5 to 10 years. **Figure 20** shows the locations of the case studies. The three locations and their associated case studies are:

- Southcentral Alaska: Lower Cook Inlet
 - One fixed bottom (shallow-water) offshore wind case study with export cable to Homer and hydrogen electrolysis in Homer
 - One floating (deep-water) offshore wind case study with export to Nikiski and hydrogen electrolysis in Nikiski
 - One tidal case study with export to Nikiski and hydrogen electrolysis in Nikiski.
- Alaska Peninsula and Eastern Aleutians: Dutch Harbor
 - One floating offshore wind case study with hydrogen electrolysis in Dutch Harbor.
- Western Alaska: Nome
 - Two fixed-bottom offshore wind case studies with hydrogen electrolysis at Port of Nome.

In addition to the two offshore wind case studies and one tidal case study in Southcentral Alaska, we also examined an offshore wind scenario with no hydrogen electrolysis that models offshore wind serving the Railbelt grid from a Cook Inlet location.

Along with techno-economic analysis, each case study includes some information about fishing (subsistence, personal use, and commercial), presence of rare, threatened, and endangered species, nesting birds, and other key natural resources. Alaska's OCS supports numerous marine species, and those species contribute to a thriving commercial and subsistence fishing industry. Alaska produces about 60% of the nation's commercial fisheries, including all five species of Pacific salmon, four species of crab, Pacific cod, various types of groundfish, herring, sablefish, pollock, and Pacific halibut (Alaska's fishing

... [date unknown]). Some of the species in the OCS are threatened or endangered and have critical habitats. Understanding the extent of these species and their habitats can ensure proper siting of renewable energy projects so that they do not unreasonably interfere with other uses of the OCS. Additional information about the case study locations is shared in more detail below and analyzed in subsequent sections of this report.

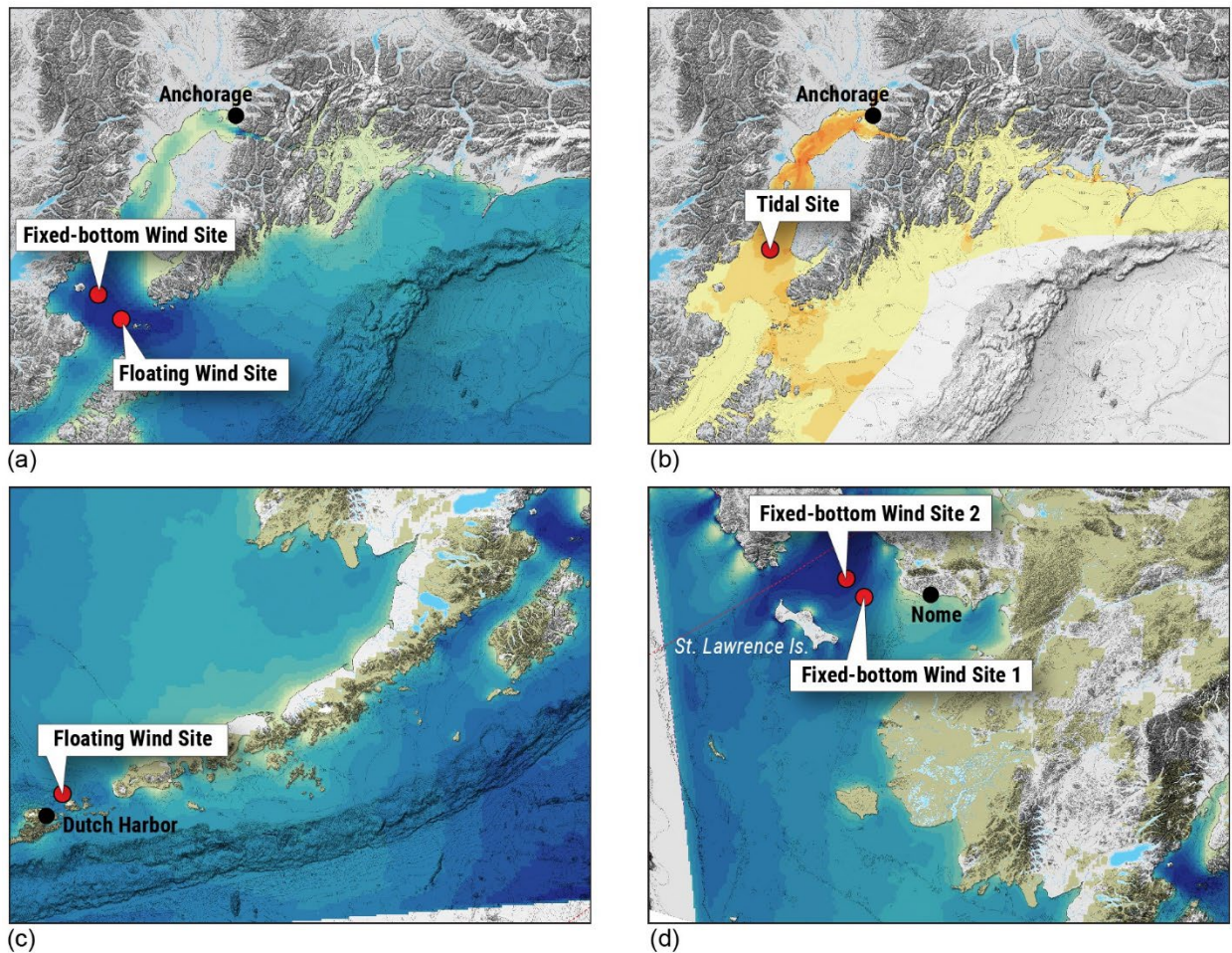

Figure 20. Maps showing locations of case studies

The specific case studies include (a) two offshore wind case studies in Southcentral Alaska (Lower Cook Inlet), (b) one tidal case study in Southcentral Alaska (Lower Cook Inlet), (c) one offshore wind case study in Alaska Peninsula and Eastern Aleutian Islands (Dutch Harbor), and (d) two offshore wind case studies in Western Alaska (Nome). Illustrations by NREL

4.2 Site-Specific Information

4.2.1 Ports

There are port infrastructure needs and requirements related to ocean energy project construction and operations and maintenance (O&M). Ports supporting offshore wind construction should have space to stage wind farm components and be able to host installation vessels up to 500 feet in length as well as smaller support vessels. Most installation activities for fixed-bottom wind turbines occur at sea, but where there will be assembly of floating offshore wind structures at port, additional capabilities are needed,

including a port-based workforce, heavy-lift cranes, and adequate space for dry and floating storage. Approximate criteria for offshore wind construction and O&M at ports are shown in **Table 10**, followed by parallel information from the three ports that are included in our case study analysis in **Table 11**.

Table 10. Criteria for offshore wind ports

Floating Offshore Wind Turbine	Floating Offshore Wind Staging and Integration	Fixed-Bottom Offshore Wind Staging and Integration	Offshore Wind Operations and Maintenance
Minimum draft at berth	38 ft*	32 ft	20–30 ft
Acreage, minimum	30–100 acres	15–25 acres	5–10 acres
Wharf length	1,500 ft	1,300 ft	300 ft
Wharf loading	>6,000 psf*	3,000–6,000 psf	100–500 psf

*ft = foot, psf = pounds per square foot

Source of port criteria: (ARUP 2020, Parkison and Kempton 2022, Shields et al. 2023)

Table 11. Statistics for the case study ports assessed

Floating Offshore Wind Turbine	Port of Alaska (Anchorage)	Dutch Harbor	Nome*
Minimum draft at berth	35 ft	40 ft	22 ft
Acreage, minimum	60 acres	(no information available)	43 acres
Wharf length	3,500 ft	2,000 ft	600 ft
Wharf loading	(no information available)	750 psf	(no information available)

*Information about the Port of Nome reflects current conditions; however, the port has proposed modifications that would increase the draft to 40 ft and lengthen the wharf (Port of Nome ... 2023).

The colors reflect the extent to which existing port characteristics can meet the offshore wind project needs: green = conditions within acceptable range for offshore wind project development; yellow = slightly unacceptable conditions for offshore wind project development; red = unacceptable conditions for offshore wind project development.

Source of port information: (Port of Alaska ... c2023, Unalaska marine ... [date unknown], Alaska's Arctic ... [date unknown]).

Port requirements for tidal energy and offshore wind projects are similar, although prototypes of small-scale demonstrations may have less restrictive port requirements. Also, with respect to tidal projects, installation strategies will vary due to the differences in tidal technology options.

The space needed for an electrolyzer system producing ~95,000 tonnes (1 GW with approximately 60% average yearly capacity factor) of hydrogen per year occupies approximately 35 acres. Port requirements for hydrogen production and storage vary with respect to whether hydrogen is produced on land or offshore. In cases where hydrogen is produced offshore, requirements will be similar to those for offshore wind with respect to space for staging and component storage and workforce support. There will also be a need for buffer (short-duration) storage and a hydrogen liquefaction terminal, like liquefied natural gas terminals (for shipping fuel), and a berth. Depending on the project, space may also be needed for conversion to other fuel processes and storage for that fuel (e.g., ammonia) and a berth. In cases when hydrogen is produced on land, the electrolyzer system would be installed on a platform within or near the wind farm; hence, port resource support may become irrelevant.

Port considerations are included in the case study descriptions provided in the following subsections.

4.2.2 Case Studies in Southcentral Alaska (Lower Cook Inlet)

4.2.2.1 Resource

We have identified two offshore wind sites (among likely others) within Southcentral Alaska’s Lower Cook Inlet—one shallow-water site appropriate for fixed-bottom technologies, and another deep-water site appropriate for floating offshore wind technologies (**Figure 20a**).

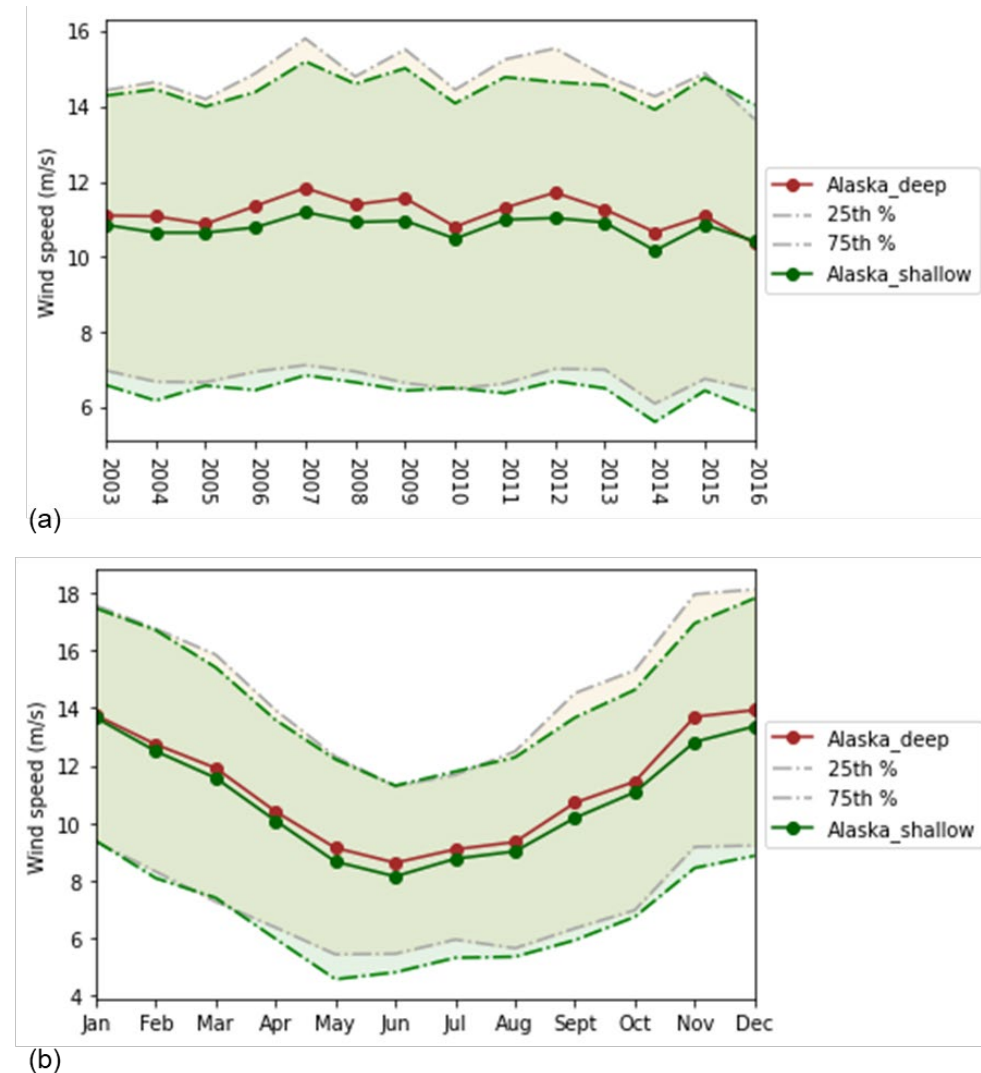

Figure 21. (a) Average simulated wind speeds per year and (b) annual cycle of average simulated wind speeds per month at the Southcentral Alaska case study sites in the Lower Cook Inlet.

The shaded area represents the interquartile range, or the spread of data between the 25th and 75th percentiles.

For the two Southcentral Alaska offshore wind case studies, annual and seasonal cycles of wind speeds for the deep and shallow-water sites (**Figure 21**) show that average wind speeds slightly decline until 2016, with average values of 11.2 m/s for the deep-water site and 10.8 m/s for the shallow-water site. Wind speeds exhibit a seasonal cycle, with lower wind speeds occurring during the spring and summer months and highest speeds occurring in November, December, and January. **Figure 21** also shows the interquartile range, i.e., the 25th and 75th percentiles, which gives an indication of the spread of the data. Wind directions (**Figure 22**) at these sites are predominantly northwest-west and southeast-east, with

another maximum northwest. This distribution is explained by the topography and orientation of the water areas and various straits in the Cook Inlet.

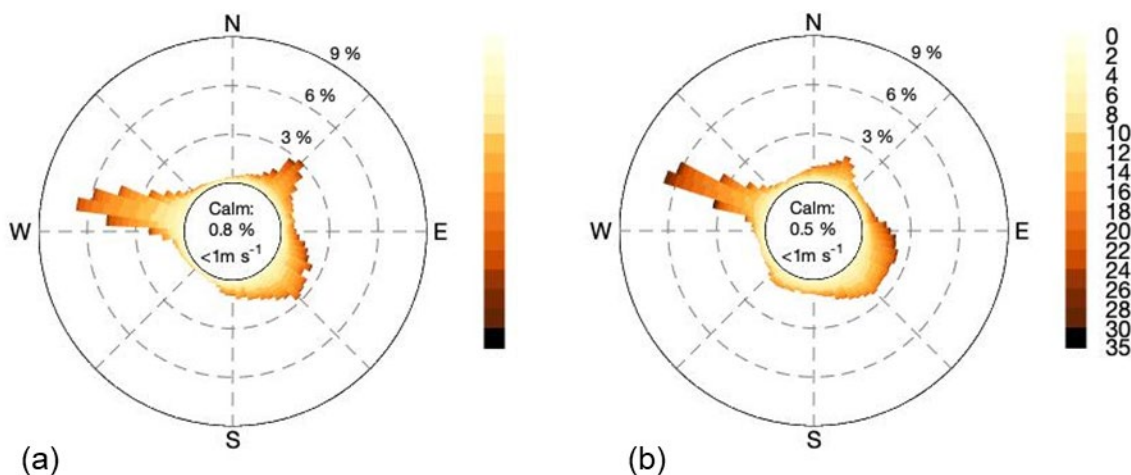

Figure 22. Wind roses of wind directions for the Southcentral Alaska offshore wind (a) shallow-water case study site and (b) deep-water case study site in the Lower Cook Inlet

Wind resource maps across a diurnal cycle (top of **Figure 23**) and every season (bottom of **Figure 23**) allow us to quantify the wind resource in Cook Inlet in more detail. While there are no major differences between daytime and nighttime hours in the Cook Inlet OCS, the resource is higher during the night in Upper Cook Inlet.

A pronounced seasonal cycle is discernible, with the lowest wind speeds in the summer and the highest wind speeds in the winter, as is usually expected in the Northern Hemisphere. Throughout the seasons, including the summer, the area where Shelikof Strait and Cook Inlet connect to the Gulf of Alaska is the most energetic and viable for wind energy, whereas most of the other regions in the Cook Inlet are below viable levels in the summer. The fall and winter have the highest wind speeds up to Turnagain Arm. Potential total installed capacity in the Cook Inlet OCS planning area has been calculated as 64,532.1 MW (**Table 3**). As mentioned in the Resource Assessment section of this report, the wind speed data are simulated. Data should be validated with measurements before projects are developed.

As for tidal energy in this region, the most energetic location is about two-thirds up the inlet where the flow is “pinched”—and therefore forced to accelerate—between the forelands offshore Nikiski. However, there are several other locations within the inlet that have sufficiently strong currents to be viable for tidal energy development. In federal waters, these include due west of Anchor Point, the Kennedy Entrance (north of the Barren Islands), and the Stevenson Entrance (south of the Barren Islands).

We have selected the tidal energy case study near Anchor Point because it is both closer to shore than the other sites and a better water depth (not so deep) for tidal technologies that exist today (see **Figure 12**). The current speeds are slower at this site, which could make it a valuable site for testing technologies that are not designed for the stronger currents at the forelands. This site also has less sediment and ice than sites to the north.

Diurnal Cycle Averages

Day

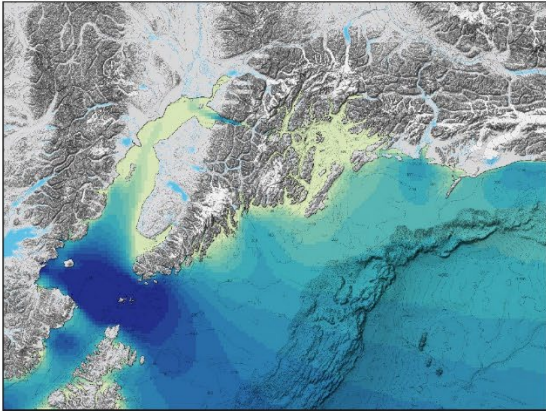

Night

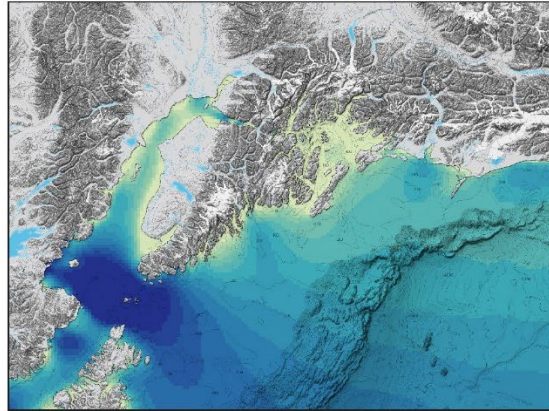

Seasonal Cycle Averages

Spring

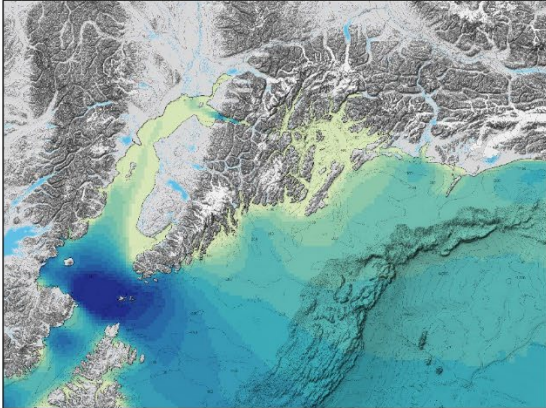

Summer

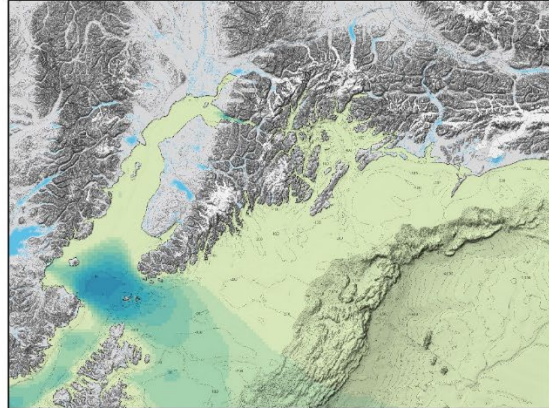

Fall

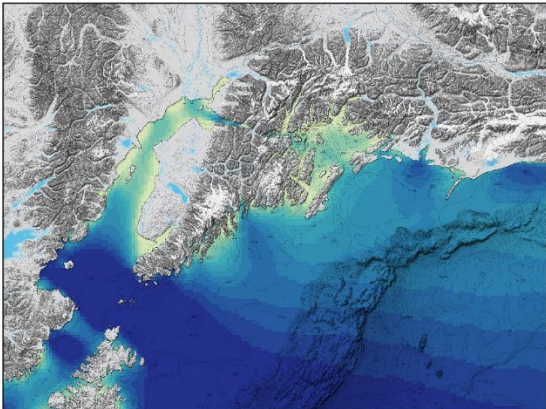

Winter

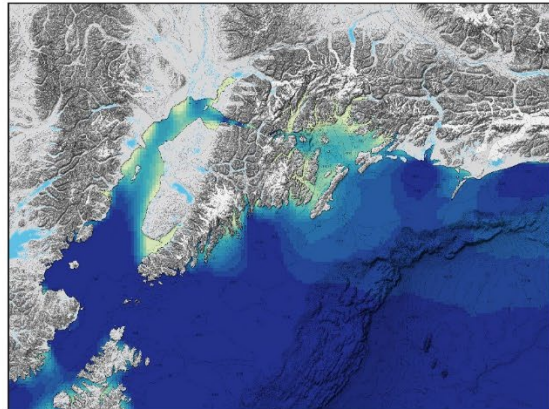

Offshore Wind Resource of Southcentral Alaska (at 100m)

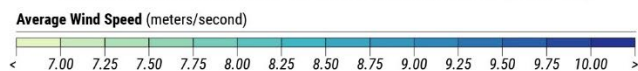

Figure 23. Average simulated wind speeds at 100 m for Southcentral Alaska during daytime and nighttime, and during spring, summer, fall, and winter

4.2.2.2 Port Considerations

The Port of Alaska could be an option in a Southcentral Alaska ocean energy project scenario. According to their website, the Port of Alaska is a versatile port that handles both fuel and freight and is adjacent to a high-population center and multiple modes of transport, including road, marine, air, and rail (Port of Alaska ... c2023). Some characteristics of the Port of Alaska are as follows (Port of Alaska ... c2023):

- 75% of all non-petroleum marine cargo enters the state through the Port of Alaska
- 3 million tons of cargo and more than 2,700 ships per year
- Wharf pilings have been decaying; a modernization program is underway beginning with cement/petroleum terminal
- 125 acres in total, including 60 acres of laydown space
- Very large tidal range (± 38 ft).

The Port of Alaska shown in **Figure 24** is undergoing a modernization program, which is a phased series of public-private projects to replace select infrastructure over the next 10 years, including a port-wide microgrid with battery, renewable generation, and emergency generation systems for power reliability and resiliency.



Figure 24. Port of Alaska

Source: (Port of Alaska ... c2023)

4.2.2.3 Environmental Considerations

The Lower Cook Inlet is rich in natural resources. The area supports several large seabird colonies and many migratory seabirds. Marine bird species include Steller's eider, which is listed under the federal Endangered Species Act (ESA), and significant populations of marbled and Kittlitz's murrelet—two species of conservation concern (BOEM 2017). The use of natural resources and wildlife viewing are important attractions for the tourism industry.

The fisheries of Alaska provide tens of thousands of seasonal and full-time jobs for more than 210 Alaska communities and the state. In many of those communities, commercial fishing provides the only significant opportunity for private sector employment. The seafood industry is one of the largest employment and economic drivers in Alaska, directly employing 58,700 people, creating an additional

10,000 secondary jobs, and producing more than \$5 billion in economic activity in Alaska every year (Alaska’s fishing ... [date unknown]).

The harvest and processing of wild resources for food, raw materials, and other uses have been a central part of the customs and traditions of many cultural groups in Alaska. Subsistence and personal uses of wild resources exist alongside other important uses of fish and game in Alaska and are especially important for most rural families, who depend on hunting and fishing as sources of nutrition and cultural practices (Subsistence in Alaska ... date unknown).

Subsistence, commercial, and personal use fishing species of Lower Cook Inlet are shown in **Table 12**. All five species of Pacific salmon, Pacific herring, and smelt are commercially harvested in the Cook Inlet area. Numerous groundfish species are commercially harvested in directed fisheries, including Pacific cod, halibut, sablefish, lingcod, and pelagic shelf rockfish (primarily black rockfish). Other groundfish species are commercially harvested as bycatch to directed fisheries. Shellfish species commercially harvested in the Cook Inlet Area are octopus and razor clams. These varied resources are assessed and managed by Alaska Department of Fish and Game in Soldotna and Homer (Commercial fisheries overview: Cook Inlet [date unknown]). Historically, the area supports subsistence and personal use fishing and includes several salmon species, halibut, Dolly Varden trout, arctic char, herring, bottom fish, crab, and shellfish (Subsistence fishing ... [date unknown]).

Table 12. Subsistence and commercial fishing species of the Lower Cook Inlet

Species	Subsistence Fishing	Commercial Fishing	Personal Use Fishing
Salmon	X	X	X
Halibut	X	X	
Herring and hooligan	X		X
Arctic char	X		
Tanner crab	X		X
Lingcod	X	X	
Rockfish	X	X	
Clams	X	X	
Smelt		X	
Pacific cod		X	
Sablefish		X	
Razor clams		X	
Octopus		X	

The purpose of the ESA is to conserve threatened and endangered species and their ecosystems. A species is considered endangered under the ESA if it is in danger of extinction throughout all or a significant portion of its range. Two federal agencies, the National Marine Fisheries Service (NMFS) and the U.S. Fish and Wildlife Service (USFWS), are responsible for maintaining lists of species that meet the definition of threatened or endangered under the ESA. NMFS is responsible for maintaining the list for most marine species and managing those species once they are listed. The USFWS is responsible for

maintaining the list for terrestrial and freshwater species, as well as three marine mammal species, and for managing those species once they are listed (Federal special status ... [date unknown]).

Critical habitat, as defined by the ESA, is the specific areas within the geographic area that contain the physical or biological features that are essential to the conservation of endangered and threatened species and that may need special management or protection (Critical habitat ... [date unknown]). Alaska has fewer than 15 species currently listed as endangered. There are currently 12 endangered species, 6 threatened species, and 4 designated critical habitat areas when considering species likely to occur in the Lower Cook Inlet as well as those found in the Cook Inlet and Gulf of Alaska (**Table 13**) (Federal special status ... [date unknown]).

Table 13. Expanded list of threatened and endangered species and critical habitat for the Southcentral Alaska case studies location

The list includes species in the Cook Inlet and Gulf of Alaska as well as species likely to occur in the Lower Cook Inlet

Species	Threatened	Endangered	Critical Habitat
Cook Inlet and Gulf of Alaska			
Blue whale		X	
Bowhead whale		X	
Eskimo curlew		X	
Leatherback sea turtle		X	
North Pacific right whale		X	
Sei whale		X	
Short-tailed albatross		X	
Sperm whale		X	
Green sea turtle	X		
Loggerhead sea turtle	X		
Olive ridley sea turtle	X		
Spectacled eider	X		
Likely to occur in the Lower Cook Inlet			
Fin whale		X	
Humpback whale		X	X
Northern sea otter (Southwest DPS)	X		X
Steller sea lion (Western DPS)		X	X
Cook Inlet beluga whale		X	X
Steller's eider	X		

4.2.2.4 Technical and Other Considerations

For ocean energy, Cook Inlet presents several unique environmental challenges, including seasonal sea ice and high suspended sediment concentrations. However, it is too early to tell if these challenges are

“show-stoppers” or simply engineering or operational challenges. Furthermore, the challenges associated with these factors may be significantly reduced in the southern inlet (federal waters) due to the lower concentrations of ice and sediment that are found there. This, in turn, could make the lower inlet an ideal site for testing early technologies before moving them to harsher conditions to the north. Tidal demonstration projects are also needed to show that these technologies can work in the inlet with research and development priorities to understand the impacts to salmon and belugas and to collect data to understand forces on the devices and fine-tune numerical models. For offshore wind energy projects, it will be important to better understand the structural impact of an offshore wind farm, be it fixed or floating, among significantly energetic waters.

Data that should be collected in demonstration projects include, but are not limited to:

- Power performance and inflow conditions
- Structural loads (forces) on devices
- Environmental monitoring: marine mammals, fish, birds, acoustic noise, water quality
- System state and control system status
- Sediment scouring and deposition
- Sediment impact on system components.

4.2.3 Case Study in Alaska Peninsula and Eastern Aleutians (Dutch Harbor)

4.2.3.1 Resource

Dutch Harbor is located relatively close to sizable offshore wind, tidal, and wave energy resources. The wave energy resource is located primarily along the southern coastline of Unalaska Island. The nearest potential tidal sites are located to the east, in the channels between Unalaska and Akutan Islands. The early state of wave and tidal energy technologies likely prohibits development of projects in this region within the next 5–10 years; thus, the Alaska Peninsula and Eastern Aleutian case study focuses on offshore wind energy opportunities in the federal waters near Dutch Harbor. Once technologies have been demonstrated in locations that have more infrastructure to support the research and development needed to commercialize them, then we recommend reevaluating the potential for deploying these technologies in this region.

An annual and seasonal cycle of wind speeds for the Dutch Harbor site (**Figure 25**) show that wind speeds have been relatively constant throughout the years with an average of 9.1 m/s. Average wind speeds exhibit a seasonal cycle, with lowest wind speeds in July and highest wind speeds in November, December, and January. Wind directions are predominantly from northwesterly directions, followed by southeasterly directions (**Figure 26**), which is due to the winds being accelerated between the islands surrounding the site.

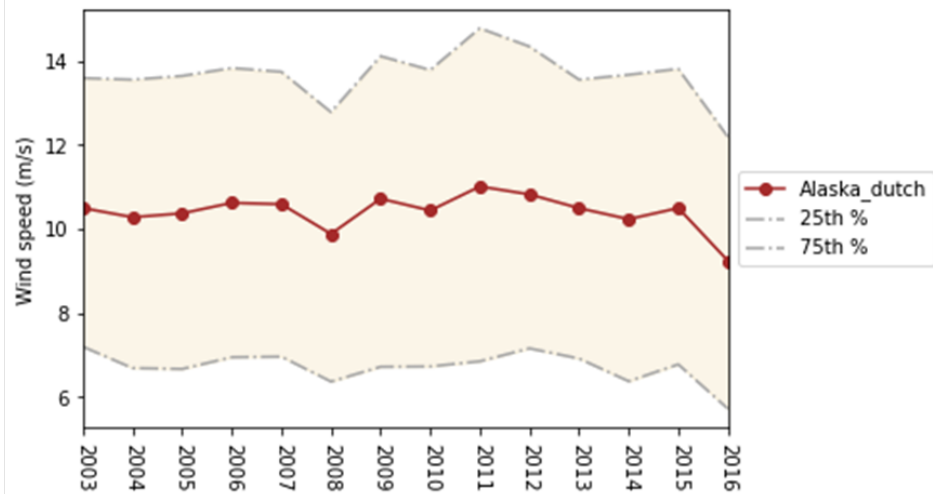

(a)

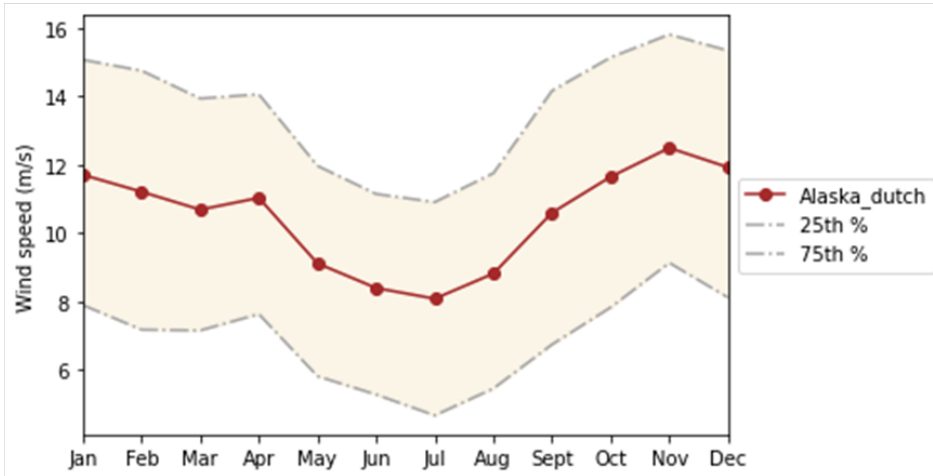

(b)

Figure 25. (a) Average simulated wind speeds per year and (b) annual cycle of average simulated wind speeds per month at the Alaska Peninsula and Eastern Aleutians case study site at Dutch Harbor.

The shaded area represents the interquartile range, or the spread of the data between the 25th and 75th percentiles.

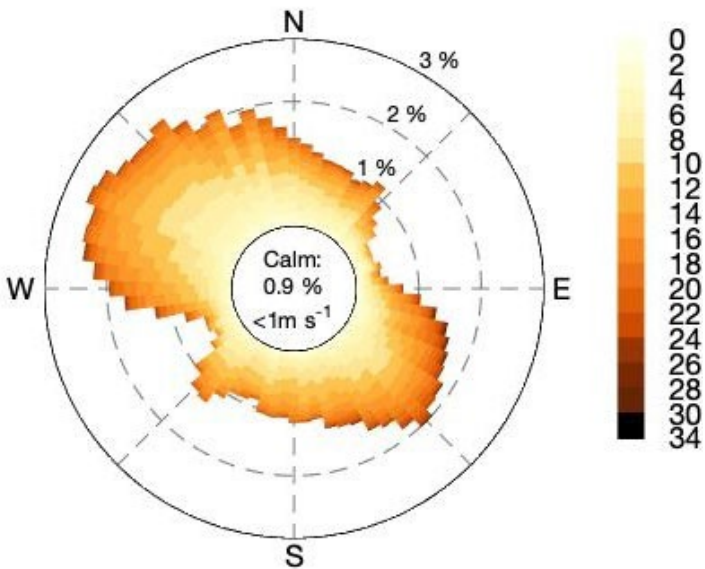

Figure 26. Wind rose for Alaska Peninsula and Eastern Aleutians case study site at Dutch Harbor

Dutch Harbor signed a 30-year power purchase agreement with Ounalashka Corporation and Chena Power for a 30-MW geothermal project at the Makushin Volcano (on Unalaska Island) (Project description ... c2020). Any economic and market analysis of the offshore wind project will need to account for the likelihood that this project is built.

4.2.3.2 Port Considerations

The Port at Dutch Harbor (**Figure 27**), in a town of approximately 4,000 residents, could be an option for siting a renewable energy project in the Alaska Peninsula and Eastern Aleutians region. Dutch Harbor is primarily a commercial fishing port on the island of Unalaska. Some characteristics of the Port at Dutch Harbor are as follows (Unalaska marine ... [date unknown]):

- Has had the largest volume catch in the United States for the past 24 years
- 1.2 million tons of cargo and more than 900 ships per year
- Deep draft berths: 45–50 ft mean lower low water
- Hilly topography may limit available area for flat storage.



Figure 27. Port at Dutch Harbor

Source: (Dutch Harbor ... [date unknown])

4.2.3.3 Environmental Considerations

The Bering Sea and Aleutian Islands are home to 450 species of fish and invertebrates, 50 species of sea birds, and at least 25 species of marine mammals. Each summer in the Bering Sea, 40 million to 50 million seabirds feed and make nests (Wildlife ... [date unknown]). Among the marine birds, Steller's eider is listed under the ESA. The use of natural resources and wildlife viewing are important attractions for the tourism industry.

The Bering Sea supports some of the largest and most valuable commercial fisheries in the United States. Many of these fisheries—including golden king crab, Tanner crab, weathervane scallops, Dungeness crab, Pacific cod, several species of flatfish, sablefish, Pacific salmon, and Pacific herring—occur within waters of Alaska and the EEZ and are regulated through a complex structure of interrelated state and federal management plans. Finfish and shellfish stocks in this area provide year-round commercial fishing opportunities and sustain important subsistence harvests for local residents (**Table 14**) (Commercial fisheries overview: Bering Sea ... [date unknown]).

Table 14. Subsistence and commercial fishing species in Dutch Harbor

Species	Subsistence Fishing	Commercial Fishing
Salmon	X	X
Halibut	X	X
Atka mackerel	X	
Crab	X	X
Sablefish	X	X
Rockfish	X	X
Pacific herring		X
Flatfish		X
Pacific cod	X	X
Sole		X
Flounder		X
Weathervane scallops		X

There are currently 11 endangered species, 5 threatened species, and 5 critical habitat areas when considering species likely to occur in Dutch Harbor as well as those found in the Bering Sea (**Table 15**) (Federal special status ... [date unknown]).

Table 15. Expanded list of threatened and endangered species and critical habitat for the Alaska Peninsula and East Aleutians case study location

The list includes species in the Bering Sea as well as species likely to occur in Dutch Harbor

Species	Threatened	Endangered	Critical Habitat
Bering Sea			
Aleutian shield fern		X	
Blue whale		X	
Eskimo curlew		X	
Fin whale		X	
North Pacific right whale		X	X
Sei whale		X	
Sperm whale		X	
Green sea turtle	X		
Leatherback sea turtle		X	
Loggerhead sea turtle	X		
Olive Ridley sea turtle	X		
Short-tailed albatross		X	
Spectacled eider	X		X
Likely to occur in the Dutch Harbor			
Humpback whale		X	X
Northern sea otter (Southwest DPS)	X		X
Steller sea lion		X	X
Steller's eider	X		

4.2.4 Case Studies in Western Alaska (Nome)

For this work we define “Western Alaska” as including the Bering Strait, Seward Peninsula, the Yukon-Kuskokwim Delta, St. Lawrence Island, and Nunivak Island. The tidal and wave energy resource data that are currently available for this region are not sufficiently accurate to be included here. Furthermore, this is another case where we recommend that the wave and tidal energy technologies be commercialized before devoting in-depth analysis to project opportunities. Therefore, we focus on the offshore wind resource of the region, which is especially energetic in the Bering Strait north of St. Lawrence Island (**Figure 16**). There are also energetic winds (>9 m/s average) across large portions of the Bering Sea that could one day be harnessed for hydrogen production and export.

For the Western Alaska case study locations, an annual and seasonal cycle of wind speeds show that average wind speeds have been relatively constant throughout the years, at 9.6 m/s for the Nome 1 site and 10.5 m/s for the Nome 2 site, with 2005 and 2006 being high-wind-speed years (**Figure 28**). Wind speeds exhibit a seasonal cycle, with lowest average wind speeds June–August and highest wind speeds in December, January, and February. Winds blow mostly from northerly directions (**Figure 29**). There

have also been land-based wind energy projects in this area—most notably in Wales, Kotzebue, and Nome. We have selected case study sites near Nome because this area is expected to receive increased attention and investment alongside existing plans to expand the Port of Nome.

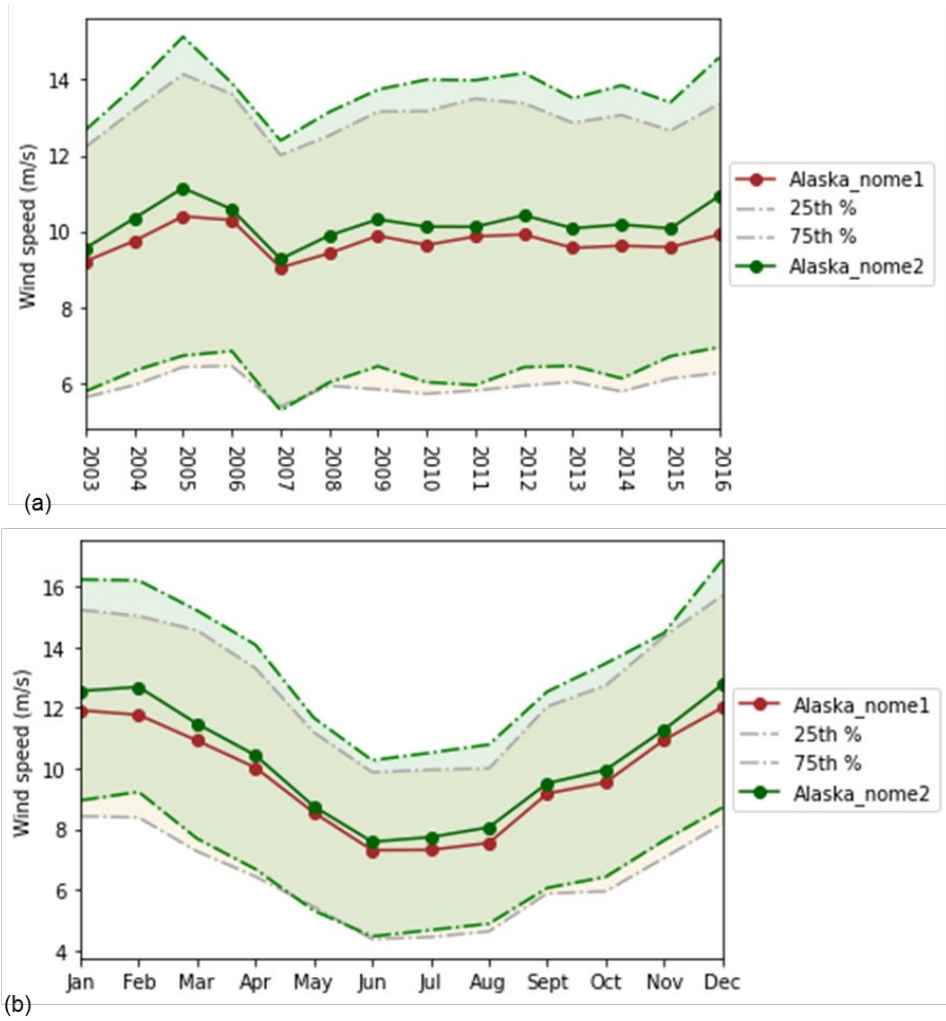

Figure 28. (a) Average simulated wind speeds per year and (b) annual cycle of average simulated wind speeds per month at the Western Alaska case study sites in Nome.

The shaded area represents the interquartile range, or the spread of the data between the 25th and 75th percentiles.

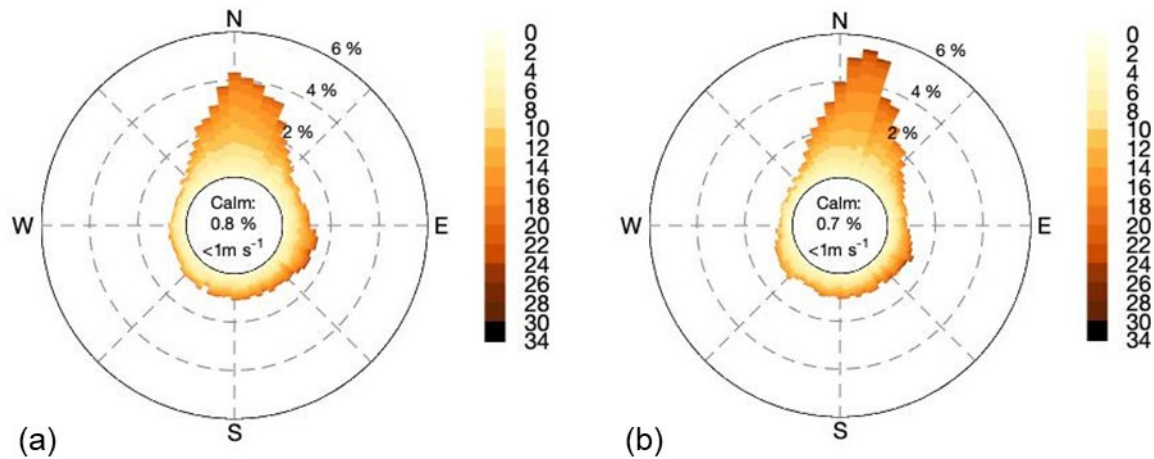

Figure 29. Wind roses of wind directions for the Western Alaska case study sites: (a) Nome 1 and (b) Nome 2

4.2.4.1 Port Considerations

The Port of Nome (**Figure 30**), in a town of approximately 4,000 residents, could be an option in a Western Alaska ocean energy project scenario. The Port of Nome is iced in and does not operate November to May and handles approximately 200,000 tons of cargo and fewer than 200 ships per year (Alaska’s Arctic ... [date unknown]).



Figure 30. Port of Nome
Source: (Alaska’s Arctic ... [date unknown])

With the pending congressionally approved Port of Nome expansion to a deep-draft port (shown in **Figure 31**), opportunities for ocean energy development could become more feasible. According to a

public meeting held on May 17, 2023, on the Port of Nome Modification (Port of Nome ... 2023), the expansion is expected to be complete by 2030 and will allow for development of the United States' only deep-water port in the Arctic. The project objective is to reduce draft limitations, increase dock space, and increase navigation area.

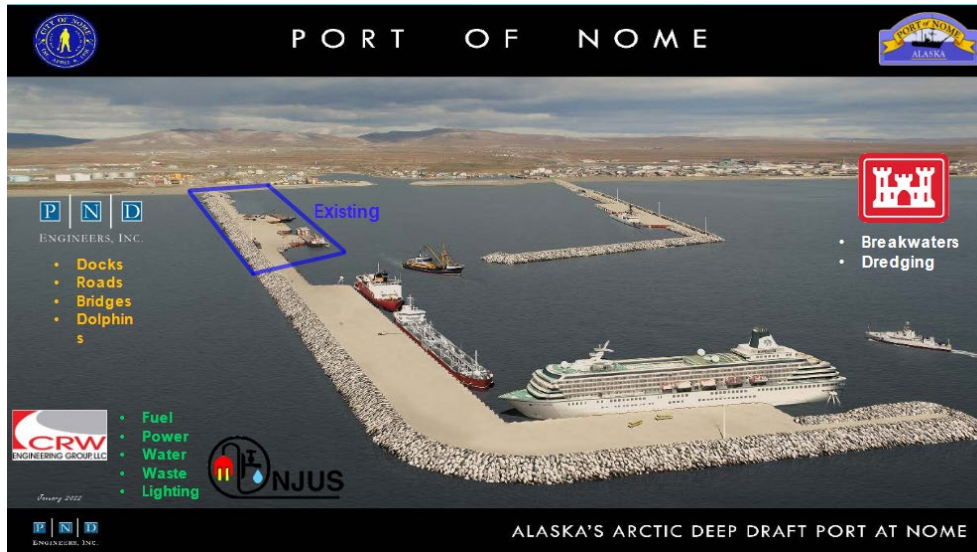

Figure 31. Port of Nome proposed expansion
Source: (Port of Nome ... 2023)

4.2.4.2 Environmental Considerations

The lands adjacent to Norton Sound are sparsely populated, but Alaska Native peoples and other rural residents depend largely on the natural environment, especially the marine environment, for fish and game food resources and materials. The environment is integrally linked with the cultural and spiritual values of these communities. Each year, indigenous communities across northern Alaska participate in hunts of multiple marine mammal species that are central to their cultural tradition and vital for subsistence.

Chum and pink salmon are abundant in Norton Sound. The remote location of herring stocks, and their later timing relative to other herring stocks, makes attracting buyers difficult for these fisheries. An important commercial and subsistence king crab fishery takes place in Norton Sound (**Table 16**) (Commercial fisheries overview: Norton Sound ... [date unknown]).

Table 16. Subsistence and commercial fishing species in Norton Sound

Species	Subsistence Fishing	Commercial Fishing
Salmon	X	X
Herring	X	X
Dolly Varden trout	X	
Whitefish	X	
Saffron cod	X	
Northern pike	X	
King crab	X	X
Bowhead whale	X	

There are currently 11 endangered species, 5 threatened species, and 2 critical habitat areas in when considering species likely to occur in the Norton Sound as well as those found in the Bering Sea (**Table 17**) (Federal special status ... [date unknown]).

Table 17. Expanded list of threatened and endangered species and critical habitat for the Western Alaska case study

The list includes species in the Bering Sea as well as species likely to occur in Norton Sound

Species	Threatened	Endangered	Critical Habitat
Bering Sea			
Blue whale		X	
Eskimo curlew		X	
Fin whale		X	
Humpback whale		X	
North Pacific right whale		X	
Sei whale		X	
Sperm whale		X	
Green sea turtle	X		
Leatherback sea turtle		X	
Loggerhead sea turtle	X		
Olive Ridley sea turtle	X		
Short-tailed albatross		X	
Spectacled eider	X		
Steller's eider	X		
Likely to occur in Norton Sound			
Bowhead whale		X	
Steller sea lion		X	X
Bearded seal			X
Ringed seal			X

5 Techno-Economic Analysis

This section details the techno-economic analysis performed at each case study location by technology type. As outlined in Section 4, the three locations and their associated case studies are as follows:

- Southcentral Alaska: Lower Cook Inlet
 - One fixed bottom (shallow-water) offshore wind case study with export cable to Homer and hydrogen electrolysis in Homer
 - One floating (deep-water) offshore wind case study with export to Nikiski and hydrogen electrolysis in Nikiski
 - One tidal case study with export to Nikiski and hydrogen electrolysis in Nikiski.
- Alaska Peninsula and Eastern Aleutians: Dutch Harbor⁹
 - One floating offshore wind case study with hydrogen electrolysis in Dutch Harbor.
- Western Alaska: Nome
 - Two fixed-bottom offshore wind case studies with hydrogen electrolysis at Port of Nome.

The offshore wind (Section 5.1) and hydrogen market (Section 5.3) analyses include all three locations, whereas the tidal energy analysis (Section 5.2) is only for the tidal energy case study in the Southcentral Alaska (Lower Cook Inlet) location. Key assumptions include the following:

- Case study locations have been selected based on our best understanding of the resource and proximity to market as well as locations where there is an existing port that can be adapted to support clean hydrogen electrolysis facilities.
- Each assessed case study exports power via cable to a land-based point of interconnection and includes clean hydrogen electrolysis facilities.
- Each assessed offshore wind case study has a plant capacity of 1 GW, with a sensitivity analysis at Lower Cook Inlet ranging from 180 MW to 1 GW.
- The tidal case study includes a 100-device array of approximately 65 MW capacity.
- Excess electricity would be used to make clean hydrogen for use in the Alaska industrial markets and/or for export. Other end-use options for hydrogen can also be studied, including the possibility of powering remote villages using fuel cells.
- In the Southcentral Alaska (Lower Cook Inlet) case studies, a 1-GW offshore wind plant would produce more electricity than the Railbelt grid could use. The level of curtailment has not yet been studied, but the oversized plant implies that there would be an additional off-taker other than the Railbelt grid.

⁹ It should be noted that the Alaska Peninsula and Eastern Aleutian offshore wind scenario and the Western Alaska offshore wind scenario would likely not exist without the clean hydrogen component, thus the reader should not make direct comparisons across LCOE values without adding in the cost of clean hydrogen production in these locations.

- Transmission upgrades are in place for the Kenai Intertie for Cook Inlet ocean energy scenarios. Plant costs for 1-GW plants do not include costs of upgrades to the land-based transmission grid to deliver electricity to the Railbelt because this is out of scope for this analysis.
- No tax credits (production tax credit [PTC] or investment tax credit [ITC]).

5.1 Offshore Wind

We considered five representative case studies for offshore wind development: two in Southcentral Alaska, one in the Alaska Peninsula Eastern Aleutians, and two in Western Alaska. For each site, we modeled the levelized cost of energy (LCOE) for a 1-GW offshore wind power plant. The LCOE represents the total cost of generating electricity over a project’s lifetime as a dollar value per megawatt-hour. We calculate LCOE using the following equation:

$$LCOE = \frac{(FCR \times CapEx) + OpEx}{AEP}$$

where FCR = fixed charge rate given in percent per year (see Section 5.1.2); CapEx = capital expenditures given in dollars per kilowatt (see Section 5.1.3); OpEx = operational expenditures given in dollars per kilowatt per year (see Section 5.1.4); and AEP = net annual energy production at each site given in kilowatt-hours per kilowatt (see Section 5.1.5).

We consider two methods of delivering energy to consumers: electrical transmission via subsea cable and conversion to hydrogen via electrolysis. Hydrogen conversion is discussed in more detail in Section 5.3; for electrical transmission, we include the cost to reach a point on shore but do not assess the cost of any grid upgrades to deliver electricity to consumers further inland.

5.1.1 Wind Power Plant Parameters

At each site, we model the cost of a 1,005-MW (~1 GW) power plant consisting of 67 15-MW wind turbines. The turbine model is the International Energy Agency Wind Technology Collaboration Programme (“IEA Wind”) 15-MW Reference Wind Turbine, which has a hub height of 150 m and a rotor diameter of 240 m. The wind turbine begins generating at a wind speed of 3 m/s (“cut-in speed”), and it reaches its rated power of 15 MW at 10.6 m/s. More detailed specifications for the wind turbine can be found in Gaertner et al. (2020).

The choice of substructure (the support structure at and below the water line, shown in yellow and black in **Figure 32**) plays a significant role in cost estimates, as substructures are second only to wind turbines in terms of capital costs. Several types of substructures are illustrated in **Figure 32**. Most offshore wind turbines today are installed on fixed-bottom foundations, but floating substructures are beginning to be deployed in deeper waters. Water depths at the Western Alaska sites and the shallow Lower Cook Inlet site are suitable for fixed-bottom foundations. In this study we report costs for monopile foundations, which are the most used foundation type for fixed-bottom wind turbines (Musial et al. 2022). At Alaska Peninsula Eastern Aleutian (Dutch Harbor) and Southcentral Alaska (Lower Cook Inlet) deep-water case study locations, the water depth is greater than 60 m, and we assume that floating wind turbines will be required. There is greater uncertainty about the types of substructures that will be used for commercial-scale floating wind projects than for fixed-bottom projects. We base cost estimates on a semisubmersible platform that is representative of the substructure type used in the largest share of announced projects (Musial et al. 2022).

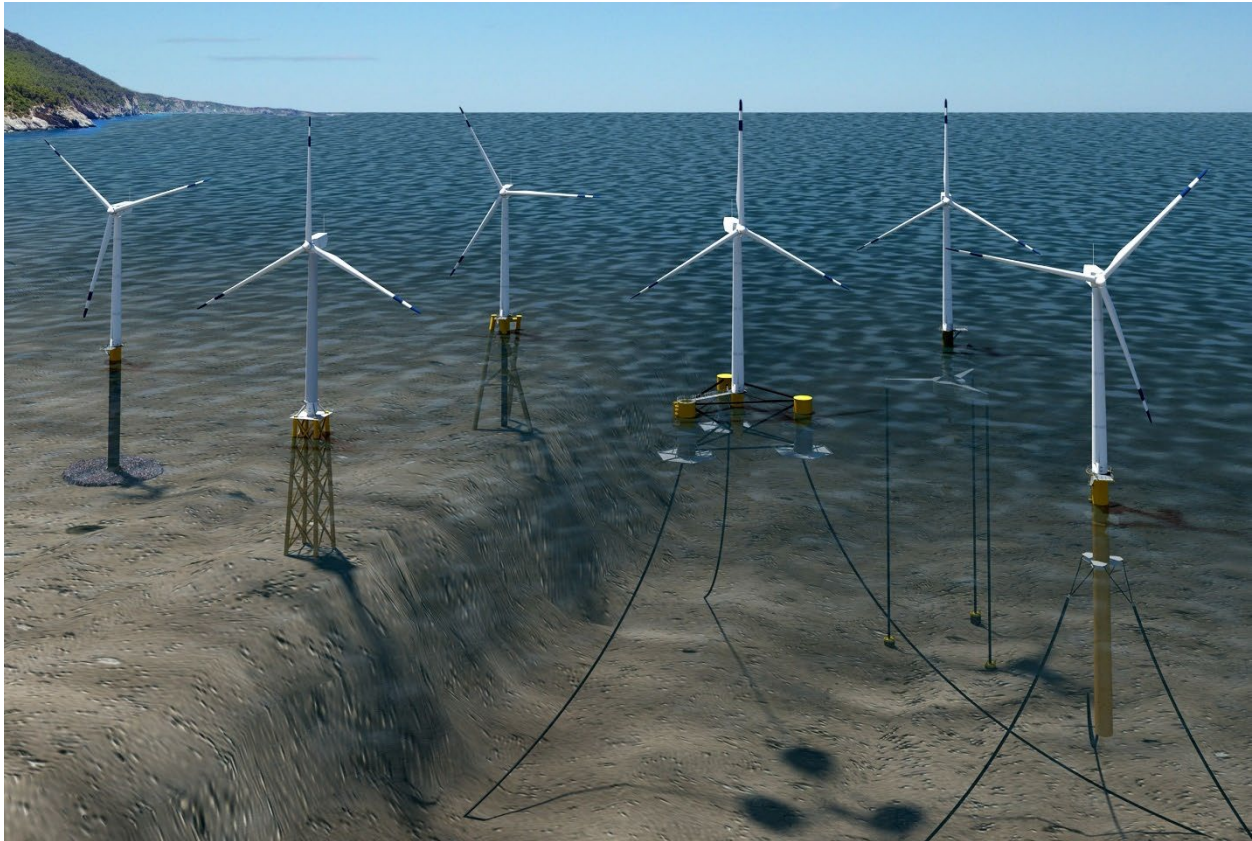

Figure 32. Offshore wind turbine substructure types

From left in the illustration: monopile, jacket, inward battered guide, semisubmersible, tension-leg platform, and spar. Illustration by Joshua Bauer, NREL

Offshore wind energy costs are also influenced by proximity to relevant onshore infrastructure, including ports and the electric grid. **Table 18** summarizes the water depths and distances to port and electrical interconnection that were used to model each of the five case studies.

Table 18. Offshore wind case study location characteristics

Characteristic	Southcentral Alaska: Lower Cook Inlet (Deep)	Southcentral Alaska: Lower Cook Inlet (Shallow)	Alaska Peninsula and Eastern Aleutians: Dutch Harbor	Western Alaska: Nome 1	Western Alaska: Nome 2
Water depth	130 m	50 m	90 m	40 m	40 m
Closest port	Port of Alaska in Anchorage	Port of Alaska in Anchorage	Dutch Harbor	Nome	Nome
Distance to port	290 km	290 km	33 km	118 km	168 km
Point of interconnection (POI)	Nikiski	Homer	Dutch Harbor	Nome	Nome
Distance to POI	185 km	100 km	33 km	118 km	168 km

5.1.2 Financing Terms

Because offshore wind energy development requires a large initial capital investment, the cost of financing that investment plays a significant role in the total LCOE. We represent financing terms using a fixed charge rate. The components that go into the FCR are listed in **Table 19**. Higher interest rates and return on equity were applied for Alaska projects compared with the U.S. average, reflecting higher perceived risks.

Table 19. Offshore wind financing inputs

Parameter	Value
Inflation rate	2.5%
Interest rate (nominal)	5%
Interest during construction (nominal)	5%
Rate of return on equity (nominal)	12%
Debt fraction	55%
Tax rate* (federal and state)	28%
Weighted average cost of capital (nominal)	7.8%
Capital recovery period	30 years
Fixed charge rate	9.4%

*Does not include any tax credits.

Offshore wind turbines are a relatively new technology, and as they have been deployed more widely, costs have tended to decrease over time. This trend can be quantified in terms of a learning rate, which relates cost reductions to the cumulative global deployment of a specific technology. For fixed-bottom and floating offshore wind turbines, learning rates of 8.8% and 11.5%, respectively (Shields et al. 2022), were applied to forecast CapEx to 2035. We relied on a summary of expert predictions to estimate OpEx cost reductions and AEP improvements for offshore wind in 2035 (Wiser et al. 2021).

5.1.3 Capital Expenditures

We used NREL’s Offshore Renewables Balance-of-system and Installation Tool (ORBIT) (Nunemaker et al. 2020) to calculate wind plant CapEx for each case study location. ORBIT incorporates physical site parameters such as water depth, wind speed, and distance to port to provide estimates of the cost to procure and install each component of the wind power plant. In addition to inputting site data for each of the case study locations, we made several adjustments to the cost estimates to account for conditions specific to Alaska. These include measures to ensure that the wind turbines can operate in cold temperatures and the substructures can withstand sea ice, as well as higher costs for labor, equipment rental, and shipping. **Table 20** summarizes the cost adjustments for offshore wind energy development in Alaska.

Table 20. Capital cost adjustments for Alaska offshore wind case studies

Description	Model Adjustment
Cold weather package (e.g., low-temperature lubricants, anti-ice coatings, nacelle and blade heating) required for all wind turbines	Increase wind turbine CapEx by 10%
Ice-resistant substructures required in the Bering Sea	Add \$54/kW to substructure costs at Nome sites
Labor and equipment rental costs are higher in Alaska than the U.S. average	Increase labor and equipment portions of installation CapEx by 33% and 14%, respectively
Higher costs associated with transporting materials to Alaska	Add cost of transport from Seattle to wind farm CapEx
Port upgrades and specialized vessels are required to support offshore wind	Increase project development costs by \$200 million

Table 21 provides a breakdown of the capital costs for the five offshore wind case study sites, presented in units of dollars per kilowatt for a commercial operations date of 2035. Procurement of the wind turbines and their substructures (floating platforms at Dutch Harbor and the deep-water Cook Inlet site, and monopiles at the other three sites) represent more than half of the total capital costs. The procurement cost includes transportation from the U.S. West Coast, which leads to variation between locations. Substructure costs also vary with depth at the three fixed-bottom sites.

Table 21. CapEx breakdown for 1-GW offshore wind power plants in 2035

CapEx Line Items (\$/kW)	Southcentral Alaska: Lower Cook Inlet (Deep)	Southcentral Alaska: Lower Cook Inlet (Shallow)	Alaska Peninsula and Eastern Aleutians: Dutch Harbor	Western Alaska: Nome 1	Western Alaska: Nome 2
Procurement					
Wind turbine	\$1,465	\$1,503	\$1,633	\$1,847	\$1,847
Substructure	\$1,150	\$713	\$1,337	\$844	\$863
Mooring system	\$120	-	\$113	-	-
Array cables	\$51	\$56	\$55	\$70	\$70
Export cable	\$459	\$255	\$91	\$360	\$503
Offshore substation	\$738	\$498	\$296	\$574	\$726
Installation					
Wind turbine	*	\$134	*	\$98	\$109
Substructure	\$106	\$72	\$49	\$54	\$59
Mooring system	\$63	-	\$57	-	-
Array cables	\$29	\$32	\$28	\$30	\$31
Export cable	\$57	\$31	\$9	\$31	\$45
Offshore substation	\$8	\$9	\$5	\$6	\$7
Project development and soft costs	\$1,137	\$989	\$988	\$1,065	\$1,137
Total CapEx (\$/kW)	\$5,385	\$4,292	\$4,661	\$4,980	\$5,397

*Installation of floating wind turbines is combined with floating substructure installation

5.1.4 Operational Expenditures

Although CapEx makes up the largest share of the cost of offshore wind energy, OpEx is also a significant contributor over time, representing between 14% and 34% of LCOE (Lazard 2023, Stehly and Duffy 2022). OpEx encompasses all of the costs associated with operating an offshore wind facility, including day-to-day maintenance activities, major component repairs, vessel operations, insurance, lease payments, and site monitoring. For the five case study sites, we generated initial OpEx estimates based on the wave climate and distance to port, following the methodology of Beiter et al. (2016). These initial estimates were then adjusted for Alaska using the additional cost factors in **Table 22**. The relative contributions of materials (11%), equipment (39%), labor (23%), and other expenses (26%) were based on recent data from fixed-bottom wind power plants (Yang et al. 2019). Winter ice formation in the Bering Sea prevents operations from the port of Nome between November and May, which would limit access to a wind power plant at the Western Alaska (Nome) case study locations. Alternative methods for accessing the wind turbines, such as helicopters, would add to the cost of operations and maintenance.

Table 22. Operational cost adjustments for Alaska offshore wind energy

Description	Model Adjustment
Lack of winter access to projects in the Bering Sea increases O&M costs	Increase OpEx by 15%
Labor and equipment rental costs are higher in Alaska than the U.S. average	Increase labor and equipment portions of OpEx by 33% and 14%, respectively
Higher costs associated with transporting materials to Alaska	Increase materials portion of OpEx by 25%

We estimate annual OpEx costs for the five case study locations to be between \$59/kW and \$74/kW, with the upper end of the range corresponding to the sites in Western Alaska near Nome where accessibility is limited.

5.1.5 Annual Energy Production

The wind resource at each case study location is described in Section 3.3. The annual average wind speeds at the case study locations varied from about 9 m/s to about 12 m/s across sites and years. Within the year, however, the sites show a strong annual cycle of average wind speeds with the lowest wind speeds occurring in the summer months (**Figure 33**).

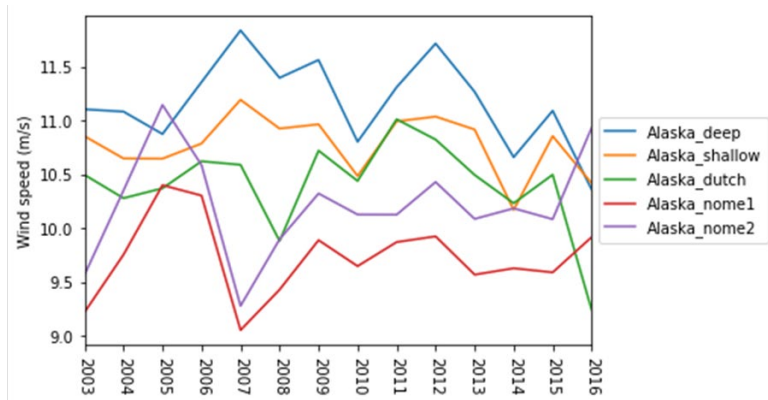

(a)

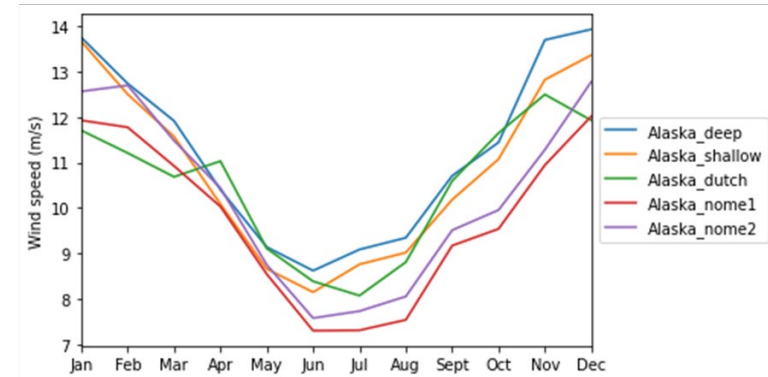

(b)

Figure 33. (a) Average simulated wind speeds per year and (b) annual cycle of average simulated wind speeds at all offshore wind case study locations

“Alaska_deep” and “Alaska_shallow” represent the deep-water (for floating wind turbines) and shallow-water (for fixed-bottom turbines) offshore wind case study sites in the Southcentral Alaska Lower Cook Inlet region.

We used the IEA Wind 15-MW Reference Wind Turbine power curve (Gaertner et al. 2020) to convert the site-specific wind speed time series data to wind plant power output. Taking the sum over a full year provides an estimate of the gross AEP. To obtain the net AEP, we applied the loss factors listed in **Table 23**. For the five case study locations, net AEP for a 1-GW offshore wind plant was estimated to be between 4,500 GWh and 4,880 GWh per year.

Table 23. Loss factors for Alaska offshore wind energy

Loss Factor	Value
Wake losses	8%
Environmental losses (incl. ice)	3%
Technical losses	1.3%
Electrical losses	3%
Availability losses	6%
Total losses*	20%

*Total losses: $1 - (1 - 8\%) \times (1 - 3\%) \times (1 - 1.3\%) \times (1 - 3\%) \times (1 - 6\%) = 20\%$

5.1.6 Results and Discussion

Table 24 summarizes the CapEx, OpEx, AEP, and LCOE for each offshore wind case study location. The cost of energy is lowest at the Southcentral Alaska Lower Cook Inlet fixed-bottom location and highest at the Western Alaska Nome 2 location, which is the more distant of the two locations from Nome. The LCOE estimates for Alaska case study locations are higher than NREL’s Annual Technology Baseline (ATB) estimates for offshore wind in 2035. Locations with comparable wind resources in the conterminous United States are projected to have an LCOE of \$43.64/MWh for fixed-bottom or \$46.85/MWh for floating offshore wind energy under the “moderate” technology assumptions in the ATB (NREL 2022). The difference in LCOE is primarily a result of higher costs for materials, labor, and equipment, as well as the assumption that developers would need to invest more in infrastructure to build a project in Alaska.

Table 24. Estimated LCOE in 2035 for 1,000-MW offshore wind case studies

LCOE Inputs and LCOE	Southcentral Alaska: Lower Cook Inlet (Deep)	Southcentral Alaska: Lower Cook Inlet (Shallow)	Alaska Peninsula and Eastern Aleutians: Dutch Harbor (Deep)	Western Alaska: Nome 1 (Shallow)	Western Alaska: Nome 2 (Shallow)
CapEx (\$/kW)	\$5,385	\$4,292	\$4,661	\$4,980	\$5,397
OpEx (\$/kW/yr)	\$65	\$65	\$59	\$73	\$74
AEP (kWh/kW)	4,845	4,823	4,853	4,476	4,672
LCOE (\$/MWh)	\$100	\$83	\$87	\$103	\$106

The two Southcentral Alaska Lower Cook Inlet case study locations are close to the Railbelt, which represents around three-quarters of Alaska’s electricity demand. A 1-GW plant in Lower Cook Inlet would produce more than 4,800 GWh vs. the existing total Railbelt load of 4,407 GWh. Total annual

electricity demand is 53.6 GWh in Dutch Harbor and 31.6 GWh in Nome (see Section 3 for more information). Energy production from a 1-GW plant would require additional demand such as clean hydrogen production, which is discussed later in this section.

We also analyzed costs for offshore wind power plant sizes of approximately 100 MW and 200 MW that could meet local electricity demand in the Railbelt. NREL is analyzing different renewable energy scenarios that could meet an 80% RPS on the Railbelt by 2040. As part of this analysis, NREL is running a capacity expansion model using the PLEXOS modeling platform (developed by Energy Exemplar) to determine the least-cost investment strategy for the Railbelt to reliably meet its electrical demand every year between 2023 and 2040. Two of the hypothetical offshore wind projects in Alaska (floating and fixed-bottom in the Lower Cook Inlet near Nikiski) are included in the model. The costs and net annual energy production for these sites are shown in **Table 24**. The model holistically determines the cost-competitiveness of offshore wind energy generation compared to all other energy generation technologies; notably, this includes land-based wind throughout the Railbelt, as can be seen on **Figure 34**. Although the total costs are lower to build smaller offshore wind power plants, the costs per kilowatt of capacity are higher (**Table 25**).

Table 25. Estimated LCOE in 2035 for 105-, 195-, and 1,000-MW offshore wind power plants in Cook Inlet

LCOE Inputs and LCOE	Fixed-Bottom 105 MW	Fixed-Bottom 195 MW	Fixed-Bottom 1,000 MW	Floating 105 MW	Floating 195 MW	Floating 1,000 MW
CapEx (\$/kW)	\$6,621	\$5,275	\$4,292	\$7,503	\$6,018	\$5,385
OpEx (\$/kW/yr)	\$65	\$65	\$65	\$65	\$65	\$65
AEP (kWh/kW)	4,823	4,823	4,823	4,845	4,845	4,845
LCOE (\$/MWh)	\$122	\$100	\$83	\$136	\$112	\$100

The cost estimates provided in **Table 25** and elsewhere in this report may be subject to substantial revision over time due to the dynamics of the domestic and global renewable energy markets while this report was being written. The absolute values of these cost estimates will likely be higher as additional market factors are taken into account, such as supply chain premiums, regional infrastructure deficiencies, transportation and shipping constraints, and gaps in workforce skills. In addition, the global offshore wind sector has recently encountered major economic headwinds resulting in rising costs and dynamic market conditions. Since 2014, European offshore wind projects have reported a steadily decreasing trend in the LCOE that is reflected in the bottom row of **Table 25**. However, while this report was being written, a combination of high inflation, global supply chain disruptions, and soaring interest rates have drastically reversed this global trajectory, with offshore wind project costs increasing as much as 65%. Although commodity prices appear to have had a shorter-term impact on project costs and have returned to lower levels during 2022–2023, interest rates remain high in 2023, and long-term supply chain issues are likely to persist for many years. The extent to which the ITC bonus provisions under the Inflation Reduction Act (IRA) might be able to mitigate this cost rise and perhaps uniquely help projects in Alaska is uncertain, but because most development timelines extend beyond the 2032 expiration of the IRA, its support may not be available.

As such, the reader should focus on the relative differences among the geospatial cost differences in offshore wind when comparing different sites. Similarly, the reader should focus on the relative differences when comparing different technologies.

Alaska’s natural gas prices are difficult to predict in the coming decades, whereas wind and solar photovoltaic capital costs are expected to return to a decreasing trend as the global markets and supply chains mature and expand. Therefore, renewable energy technologies may present a long-term opportunity for the Railbelt to save significant fuel costs in the 2035–2050 time frame. Due to an upcoming shortage of natural gas in the Cook Inlet, the model assumes that the Railbelt begins importing liquefied natural gas from out of state starting in 2031. The proportion of the gas supply that comes from liquefied natural gas imports gradually increases throughout the 2030s. The capacity expansion model assumes the costs for 195-MW sites shown in **Table 25**.

The results of the capacity expansion study will be public in December 2023. However, in the process of setting up its inputs, we calculated detailed LCOE values for other renewable energy options, including land-based wind on the Kenai Peninsula, in the Mat-Su valley of Southcentral Alaska, and the vast lands surrounding Fairbanks in the north of the Railbelt, and compared these to the LCOE values for offshore wind as derived by this project. These LCOE values, shown in **Figure 34** and **Table 26**, include the cost of building spur lines from the land-based sites to the nearest transmission figures at an assumed cost of \$8,500/MW-km. The offshore LCOE values are roughly 60% higher than their land-based counterparts, especially in terms of land acquisition and related regulatory or permitting issues, which increase cost. Because land is generally available for land-based wind energy in this area, offshore wind energy costs could need to be reduced by at least 60% for the technology to be competitive. These calculations use land-based wind AEP on the order of 3,000 kWh/kW.

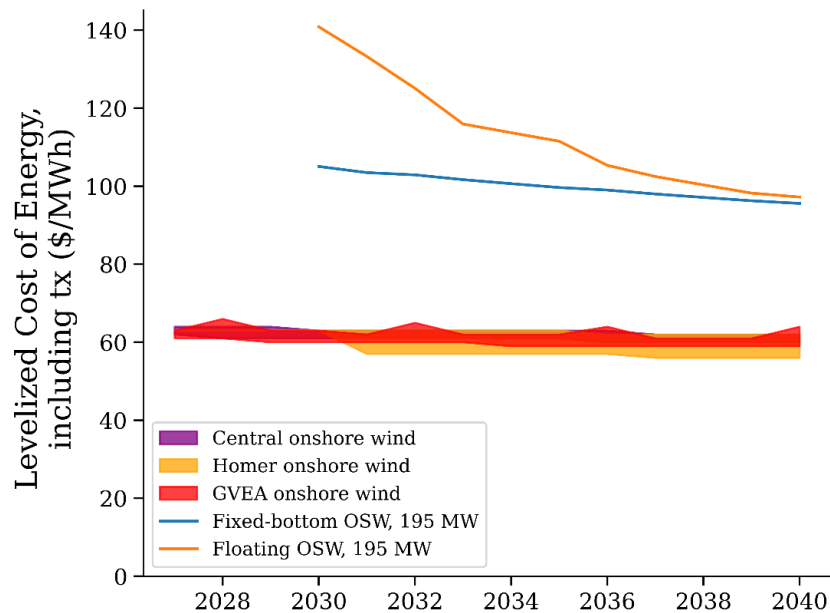

Figure 34. LCOE for land-based and offshore wind sites in the Alaska Railbelt

The colored bands represent the maximum and minimum land-based (or “onshore”) values for each zone. Offshore values are approximately 60% higher than land-based counterparts.

Table 26. Estimated LCOE for land-based wind across the Railbelt, present–2040

Year	Central (\$/MWh)	Homer (\$/MWh)	GVEA (\$/MWh)
2024			
2025		\$64	\$63
2026		\$64	\$61–63
2027	\$62–64	\$63	\$61–63
2028	\$61–64	\$63	\$61–66
2029	\$61–64	\$63	\$60–63
2030	\$61–63	\$63	\$60–63
2031	\$61–63	\$57–63	\$60–62
2032	\$61–63	\$57–63	\$60–65
2033	\$61–63	\$57–63	\$60–62
2034	\$61–63	\$57–63	\$59–62
2035	\$61–63	\$57–63	\$59–62
2036	\$60–63	\$57–62	\$59–64
2037	\$60–62	\$56–62	\$59–61
2038	\$60–62	\$56–62	\$59–61
2039	\$60–62	\$56–62	\$59–61
2040	\$60–62	\$56–62	\$59–64

5.2 Tidal Energy

Tidal turbines harnesses energy from tidal currents, much like wind turbines harness power from blowing wind. Tidal turbines are an emerging technology, and many competing archetypes exist (PRIMRE ... 2023). Consequently, tidal energy technology costs are both higher and come with more uncertainty than more mature renewable technologies like wind turbines and solar panels.

The two most popular tidal turbine designs are axial-flow and cross-flow turbines. Axial-flow turbines resemble traditional wind turbines, as kinetic energy in the fluid flow is captured by rotating blades facing the direction of fluid motion. Axial-flow turbines can incorporate blade pitch control to alter device performance based on fluid flow conditions. Cross-flow turbines capture kinetic energy from a fluid flow with rotating blades oriented perpendicular to the direction of flow. Cross-flow turbines can be mounted in a vertical or horizontal position. Both axial- and cross-flow turbines can be open or shrouded and can be installed anywhere in the water column with either fixed or floating foundations.

5.2.1 Tidal Power Plant Parameters

In this study we use a specific device design, the “Reference Model 1” (RM1) device, in our economic analysis. However, this design is a mostly hypothetical device, designed by national lab and university researchers for the purpose of establishing a baseline for tidal energy technology modeling and economic analysis (Neary et al. 2014). The RM1 device has not been built or tested at full scale, but similar devices

(like the SeaGen turbine) have been operating for several years. We use the RM1 device because we have the most comprehensive and publicly available cost and performance estimates for it.

The RM1 device is a dual-rotor axial-flow turbine with a monopile foundation and a neutrally buoyant cross-arm assembly that supports two rotors (**Figure 35**). The cross-arm rotor assembly has a total width of 48 m from blade tip to tip. In the original RM1 design, each rotor was 20 m in diameter with 28 m between the two rotors on the cross arm; however, for this analysis we assume a slightly larger rotor diameter of 25 m. The tower height is 45 m with 15 m embedment.

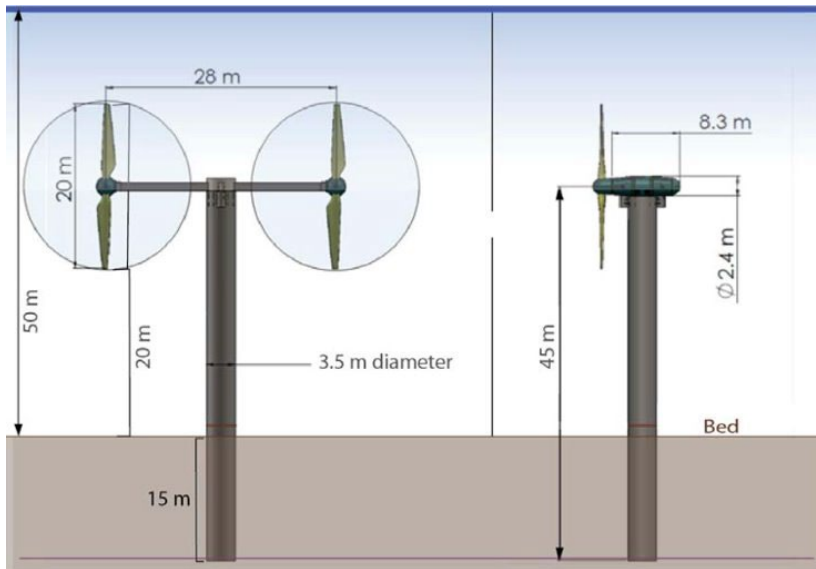

Figure 35. Reference Model 1

Source: Neary et al. (2014)

The Southcentral Alaska tidal array case study is located west of Anchor Point in Alaska's Lower Cook Inlet. The site is a 2.5-square-mile area with an average water depth of 50 m and is 35 km from shore (**Figure 36**). We selected this site because it is in federal waters, is appropriate depth for the RM1 device, has strong currents compared to other federal sites, and is relatively close to the local transmission grid at Anchor Point. Though it is important to note that the grid at Anchor Point would need substantial upgrades to handle a large power source at this location, we do not include these costs in our analysis.

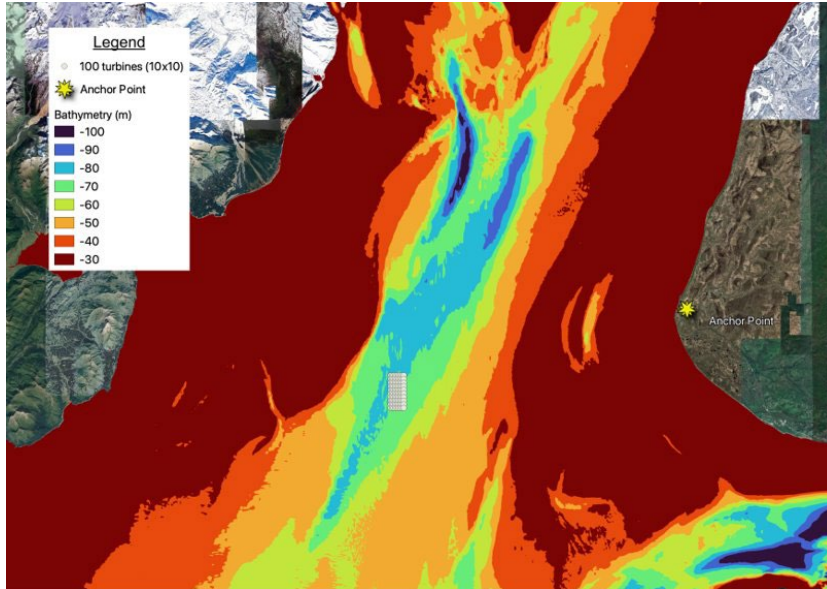

Figure 36. Tidal case study bathymetric map
Illustration by NREL

5.2.2 Financing Terms

The LCOE analysis follows the DOE’s Marine Energy LCOE guidance (Jenne and Baca 2019), which recommends a standardized method for estimating LCOE using a fixed charge rate (FCR) of 10.8%.

The FCR used for tidal energy is higher than that used for wind and other mature technologies. It would be unlikely for an emerging technology like tidal energy to obtain similar financial terms as wind energy until the technology is de-risked through future deployments that expand the cumulative installed capacity of the technology.

5.2.3 Capital Expenditures

Capital expenditures include the cost of the device, balance of system costs, and financial costs for the lifetime of the project, which is assumed to be 20 years. For this analysis, development and installation costs are estimated for the Alaska location.

5.2.3.1 Development Costs

Permitting and leasing costs are based on West Coast offshore lease costs of \$2,061 per acre. Environmental monitoring costs are based on monitoring for three species (e.g., any combination of fishes, marine mammals and/or avian species) for two summers. The resource and metocean assessment costs include the cost of purchasing and deploying a metocean buoy as well as engineering analysis and reporting activities. Geological and bathymetry survey costs are estimated to be \$62,500, which includes survey and reporting costs.

Table 27 shows a cost breakdown of development costs assumed for the simulation.

Table 27. Tidal project development costs

1.2.1	Description	Cost
1.2.1.1	Site selection (siting and scoping)	\$275,000
1.2.1.1.1	Initial resource assessment	\$75,000
1.2.1.1.2	Environmental scoping	\$50,000
1.2.1.1.3	Pre-FEED	\$150,000
1.2.1.2	Permitting and leasing	\$3,165,696
1.2.1.3	Professional advisory Services	\$150,000
1.2.1.4	Initial engineering	\$350,000
1.2.1.5	Site characterization	\$2,312,500
1.2.1.5.1	Environmental surveys	\$1,800,000
1.2.1.5.2	Resource and metocean assessment	\$450,000
1.2.1.5.3	Geological and bathymetry survey	\$62,500
1.2.1.6	Interconnection and power marketing	\$90,000
1.2.1.7	Project management during development	\$150,000
1.2.1.8	Financing and incentives	0
	Total (of all rows in bold text)	\$6,493,196

5.2.3.2 Installation Costs

The installation strategy requires the use of three vessels to install the monopile structure, cable infrastructure, and the device. The three vessel types include:

- Pile installation crane barge with approximately 500-ton lifting capacity
- Cable installation vessel for installing and burying the subsea cable
- A custom DP-2 moonpool vessel for installing the devices and later used as a dedicated service vessel. A moonpool is a large opening through the deck and bottom of a ship allowing for tools and instruments to be lowered into the water.

Installation costs were estimated using vessel rates and estimated time for each operation (**Table 28**).

Table 28. Tidal project installation costs

Operational Detail	Vessel Status	# of Days	Vessel Day Rate (\$/day)	100 Device Cost (\$)
Pile Installation				
Vessel mobilization from port to staging location	Mob/Demob	6.00	\$110,725	\$664,350
Transit from home port to site location	Transit	4.00	\$166,600	\$666,400
Drive piles (3 per day)	Pile install	0.33	\$164,200	\$5,473,333
Transit back to home port	Transit	4.00	\$166,600	\$666,400
Operational contingency	Standby	0.08	\$149,850	\$1,248,750
Demobilize to home port	Mob/Demob	6.00	\$110,725	\$664,350
Subtotal for Ops				\$9,383,583
Gunderboom Sound Barrier	-	-	-	\$4,500,000
Frame to transport barrier system	-	-	-	\$50,000
Mobilization/demobilization of sound barrier system	-	-	-	\$70,000
Pile Installation Total				\$14,003,583
Cable Installation				
Vessel mobilization from port to staging location	Mob/Demob	6.00	\$45,432	\$272,592
Transit from staging location to deployment site	Transit	4.00		
Install cables to device	Install ops	0.50	\$74,784	\$3,739,200
Secure and unsecure cable segment to pile	Install ops	0.50	\$74,784	\$3,739,200
Splice interconnect cables between each j-box	Install ops	0.50	\$74,784	\$747,840
Fairleading cables in the field	Install ops	5.00	\$74,784	\$373,920
Shore end cable through HDD	Install ops	2.00	\$74,784	\$149,568
Lay/burial of trunk cable	Install ops	4.00	\$74,784	\$299,136
Standby for testing and commissioning	Standby	4.00	\$62,924	\$251,696
Transit back to home port	Transit	4.00	\$45,432	\$181,728
Operational contingency	Standby	4.13	\$62,924	\$1,903,451
Demobilization	Mob/Demob	6.00	\$45,876	\$275,256
Cable Installation Total				\$11,933,587
Device Installation				
Vessel mobilization	Mob/Demob	6.00	\$74,026	\$444,156
Transit from staging location to deployment site	Transit	1.00	\$78,682	\$78,682

Operational Detail	Vessel Status	# of Days	Vessel Day Rate (\$/day)	100 Device Cost (\$)
Install devices (2 per day)	Install ops	0.50	\$106,014	\$5,300,700
Secure cable segment to pile (2 per day)	Install ops	0.50	\$106,014	\$5,300,700
Fairleading cables in field	Install ops	2.00	\$106,014	\$212,028
Transit back to staging area	Transit	1.00	\$86,854	\$86,854
Operational contingency (25%)	Standby	1.25	\$74,026	\$1,850,650
Demobilize to home port	Mob/Demob	6.00	\$74,026	\$444,156
Device Installation Total				\$13,717,926
Installation Total				\$39,655,096

5.2.4 Operational Expenditures

The O&M strategy is based on a model developed for RM1 in Neary et al. (2014). The model is modified to reflect the install location, port location, and shoreside operation location, which changes the vessel travel distances. Offshore operations are carried out using the custom DP-2 moonpool vessel, which picks up the dual-rotor cross-arm section through the moonpool and transports the assembly to the shoreside location for maintenance. The RM1 O&M strategy assumes a full-time crew of 25 people, with 5 people dedicated to the onshore operations and 20 people to the offshore operations. An average crew wage of \$45 per hour is assumed.

A full-time crew of 25 people working 2,080 hours per year costs \$2,340,000 per year, which is underutilized, even with a 100-unit array; however, maintaining 100 devices takes approximately 83.3 days, which may make this strategy difficult with shorter weather windows in Alaska. Therefore, the analysis assumed doubling the crew and the number of vessels in the reference model O&M strategy. The cost breakdown for O&M is shown in **Table 29**.

Table 29. Tidal case study project O&M cost breakdown

Cost Component	100-Device Array
Labor	\$4,680,000
Replacement parts	\$3,127,308
Consumables	\$187,432
Insurance	\$1,550,928
Environmental monitoring	\$600,000
Rent onshore ops site	\$60,000
Vessel maintenance	\$10,000
Docking fees	\$24,000
Vessel fuel	\$250,000
Offshore contingency (25%)	\$512,500
Total	\$11,002,168

NREL’s System Advisor Model was used to model the techno-economics of the 100-unit array (System Advisor Model 2022). The energy resource and single device performance described earlier were input into the simulation. Project economics assumptions for the simulation are shown in **Table 30**.

Table 30. Tidal case study project economics

Cost Category	\$ Thousands	\$/kW
Capital Expenditures	\$292,817	\$4,545
Marine Energy Converter	\$165,838	\$2,574
Structural assembly	\$45,161	\$701
Power take-off	\$92,943	\$1,443
Mooring, foundation, and substructure	\$27,734	\$430
Balance of System	\$103,386	\$1,605
Development	\$16,233	\$252
Engineering and management	\$5,250	\$81
Electrical infrastructure	\$35,170	\$546
Plant commissioning	\$4,194	\$65
Site access, port, and staging	\$2,884	\$45
Assembly and installation	\$39,655	\$616
Other infrastructure (vessels)	\$32,000	\$0
Financials	\$23,593	\$366
Project contingency budget	\$13,107	\$203
Insurance during construction	\$2,621	\$41
Reserve accounts	\$7,864	\$122
Operational Expenditures	\$10,490	\$163

The simulation results for the hypothetical 65-MW array estimate an LCOE of \$0.28/kWh are as follows:

- Capital expenditures: \$5,100/kW
- Operational expenditures: \$163/kW
- Fixed charge rate: 10.8%
- Levelized cost of energy: \$0.28/kWh.

5.2.5 Annual Energy Production

The current speed frequency distribution for the Southcentral Alaska Lower Cook Inlet tidal energy case study site near Anchor Point is shown in **Figure 37**. This location has an average current speed of 0.85 m/s. A rated speed of 1.45 m/s was selected to achieve a capacity factor of approximately 30%.

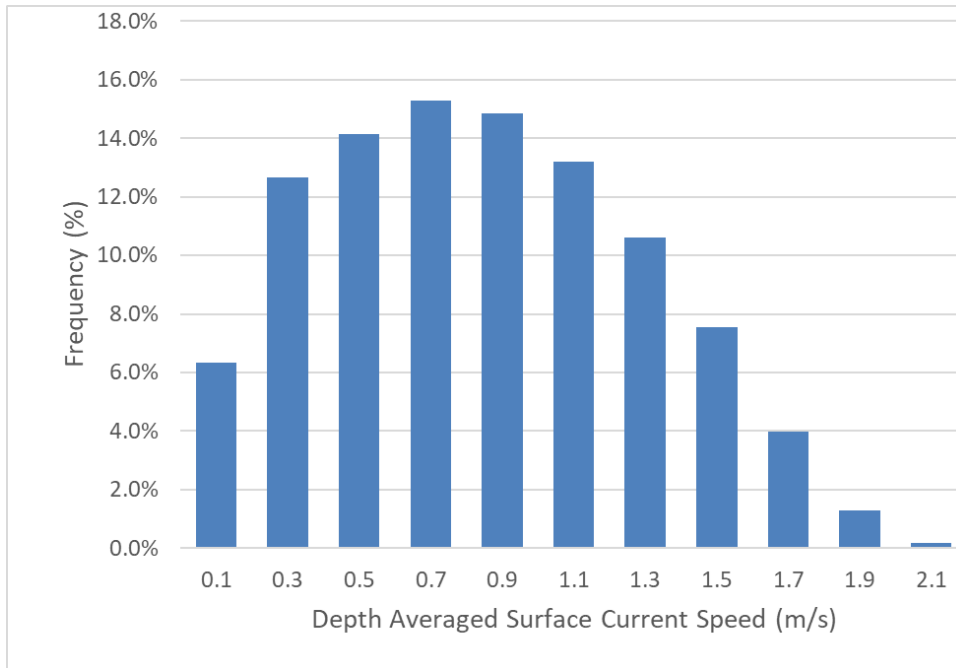

Figure 37. Lower Cook Inlet current speed frequency distribution

The amount of energy the array produces at each current speed is shown in **Figure 38**. This totals 164,757 MWh per year, and the array generates an annual average power of 20.2 MW.

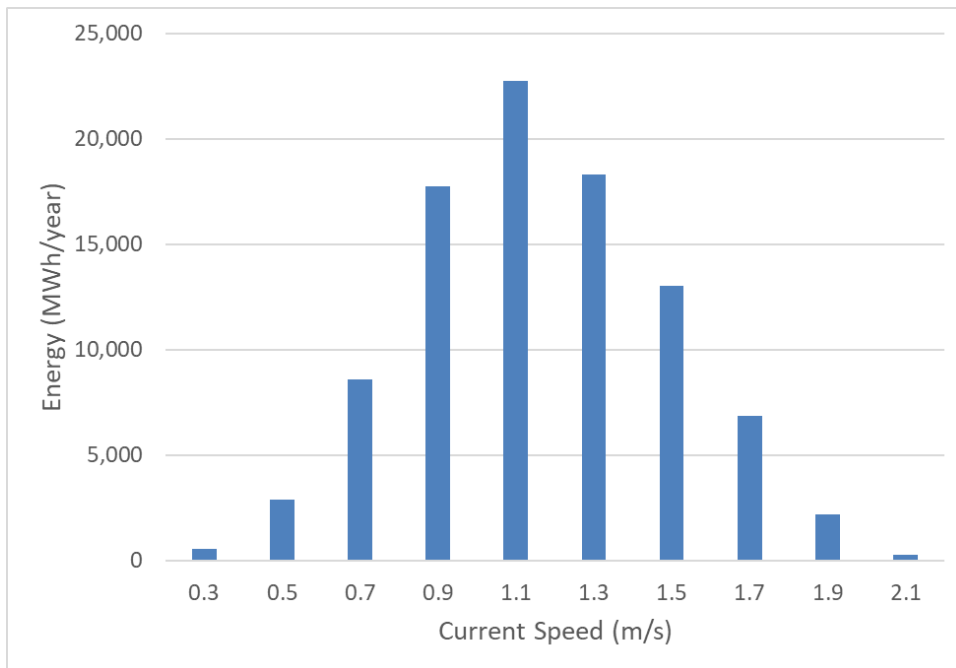

Figure 38. Annual energy production for the Southcentral Alaska Lower Cook Inlet tidal energy case study

The rated power of a single device is 644 kW at the rated current speed (rated current speed is the speed of the current at rated power) of 1.45 m/s, as shown in **Figure 39**. The coefficient of performance (the ratio of power captured by the rotor of the turbine to the total power available in the fluid flow) is assumed to be 0.42, and the machine capacity factor (how often the plant is running at rated power) is 31%. An array availability of 95% and a transmission efficiency of 98% is assumed for the 100-unit array to accommodate maintenance and/or other unforeseen events.

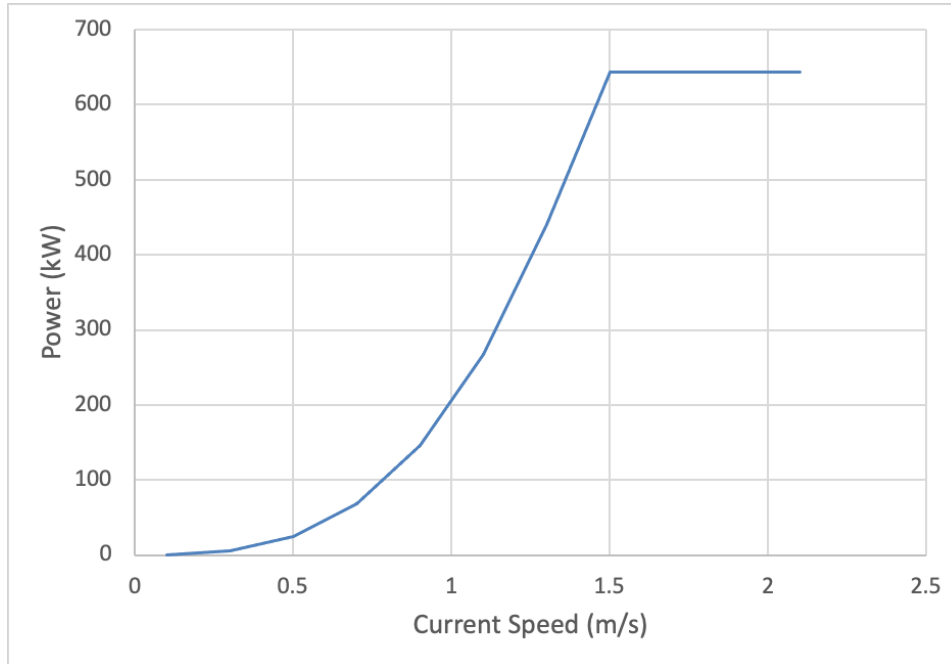

Figure 39. Southcentral Alaska Lower Cook Inlet tidal energy case study single device power curve

This estimate is unique to this design case. Present day LCOE estimates for tidal energy reported in published literature between the years 2013 to 2022 range from \$0.19/kWh to \$1.42/kWh (converted to 2022 U.S. dollars), while future LCOE estimates range from \$0.07/kWh to \$0.15/kWh for the years 2035 to 2050 (**Figure 40**).

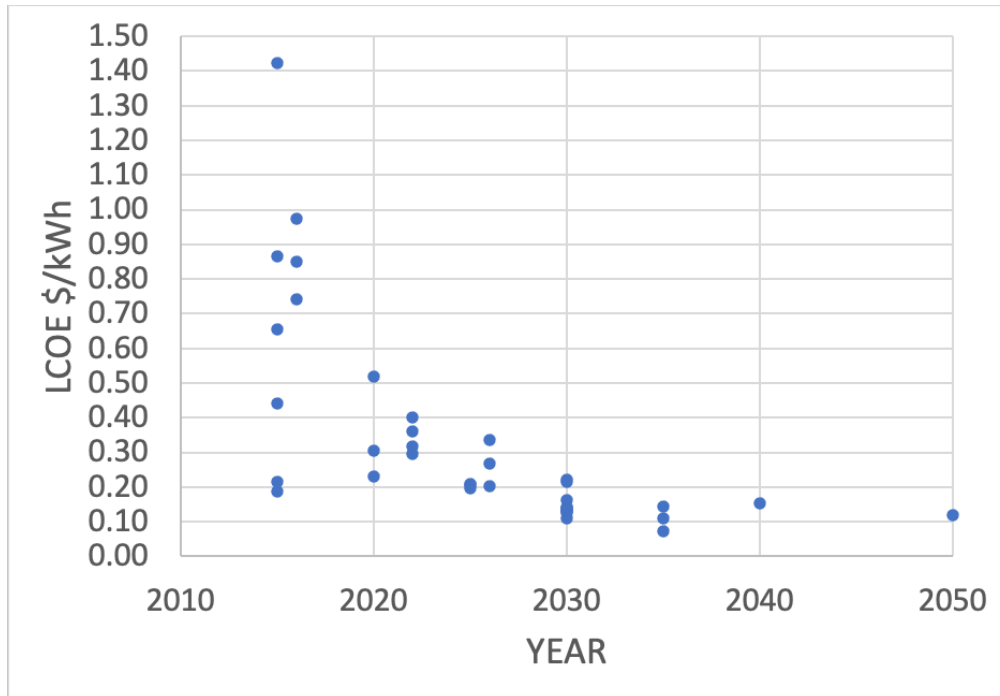

Figure 40. Tidal energy LCOE estimates over time

Source: Baca et al. (2022)

The wide range in LCOE estimates highlights the uncertainty in estimating tidal energy project costs. Cost estimates and the resulting LCOE for tidal energy have high uncertainty due to the following factors:

- Lack of tidal energy deployments in the United States
- The difference between current tidal technologies (i.e., cost and performance estimates vary across device types)
- Differences in installation and O&M strategies
- Differences in resource location
- Differences in financial assumptions used to annualize capital expenditures in the LCOE equation.

As more tidal energy devices are deployed, cost estimation will become more certain as we are able to collect actual project data. Additionally, as cumulative tidal energy capacity is installed, there is potential for LCOE reduction through learning and economies of scale.

5.2.6 Results and Discussion

As discussed earlier in the report, tidal energy devices are still at an early TRL and costs remain high; therefore, projecting how and when this renewable energy option becomes viable is difficult. The cost analysis presented here strives to balance the challenges that tidal energy technology faces while being optimistic about future potential.

Tidal energy LCOE remains more than twice as expensive as offshore wind energy alternatives in Cook Inlet. However, 30 years ago wind energy costs were significantly higher than today. Thus, tidal energy costs could follow the same trend. Until the United States invests in tidal energy demonstration projects,

it will not be possible to fully understand costs and risks associated with deploying these systems. Other factors could make tidal energy more desirable than offshore wind energy, including the predictability of the resource, the reduced viewshed concerns, and other environmental impact trade-offs.

When evaluating the impact of an 80% RPS on the Railbelt, marine energy and offshore wind energy were included in the different scenarios (**Figure 41**). This initial effort (Denholm et al. 2022) did not include economic analyses; however, it does show that ocean energy could feasibly be in the mix and could help balance supply and demand and increase resiliency. This work was the precursor to the ongoing effort described previously in Section 3.1.2.

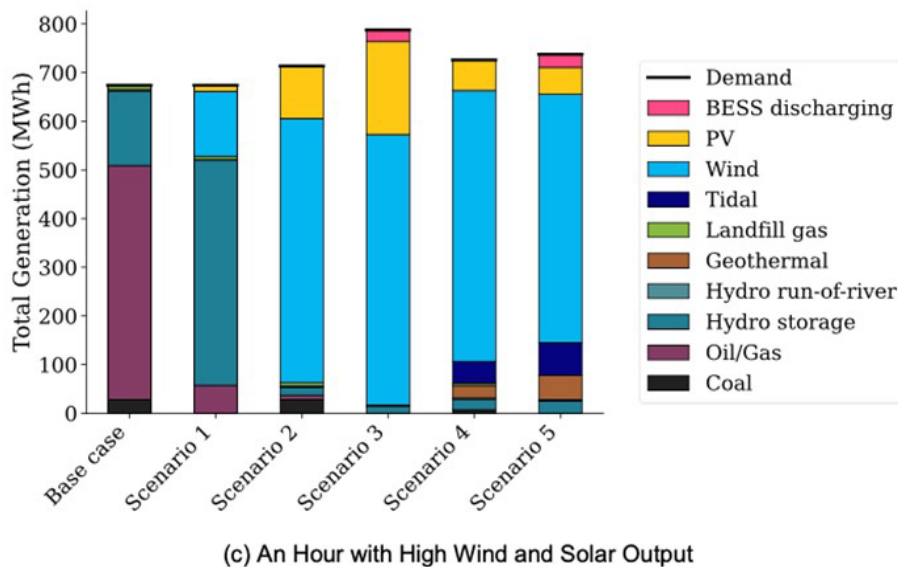

Figure 41. Renewable portfolio standard scenarios
Source: Denholm et al. (2022)

5.3 Hydrogen Production

The Bipartisan Infrastructure Law and Inflation Reduction Act in the United States allocates \$9.5 billion for clean hydrogen research and up to \$3/kg of clean hydrogen PTC, which will contribute to the DOE’s goal of reducing hydrogen production cost to \$1/kg in one decade (Hydrogen shot ... [date unknown]). Hydrogen at an affordable cost could unlock the decarbonization potential to many economic sectors, including chemical, petrochemical, iron and steel, power storage, transportation, and others, and thus play a vital role in achieving emission reductions of 50%–52% from 2005 levels by 2030 and a net-zero emissions economy by 2050 (DOE Office of Policy 2022). Further, HFTO released a clean hydrogen strategy and road map aiming at 10 MMT and 50 MMT hydrogen generation capability in the United States by 2030 and 2050, respectively (DOE 2023).

Alaska is uniquely positioned to produce clean hydrogen for supporting the United States’ and DOE’s targets, with maximum total production potential from offshore wind, wave, and tidal energy of ~303 MMT per year (**Figure 42**), 5 times the target for U.S. production by 2050. The majority of the potential is derived from the offshore wind energy resources alone, whereas tidal energy could provide the smallest portion of the three. Because the predominant potential for hydrogen production in Alaska comes from offshore wind energy, this analysis focuses solely on producing hydrogen from offshore wind resources.

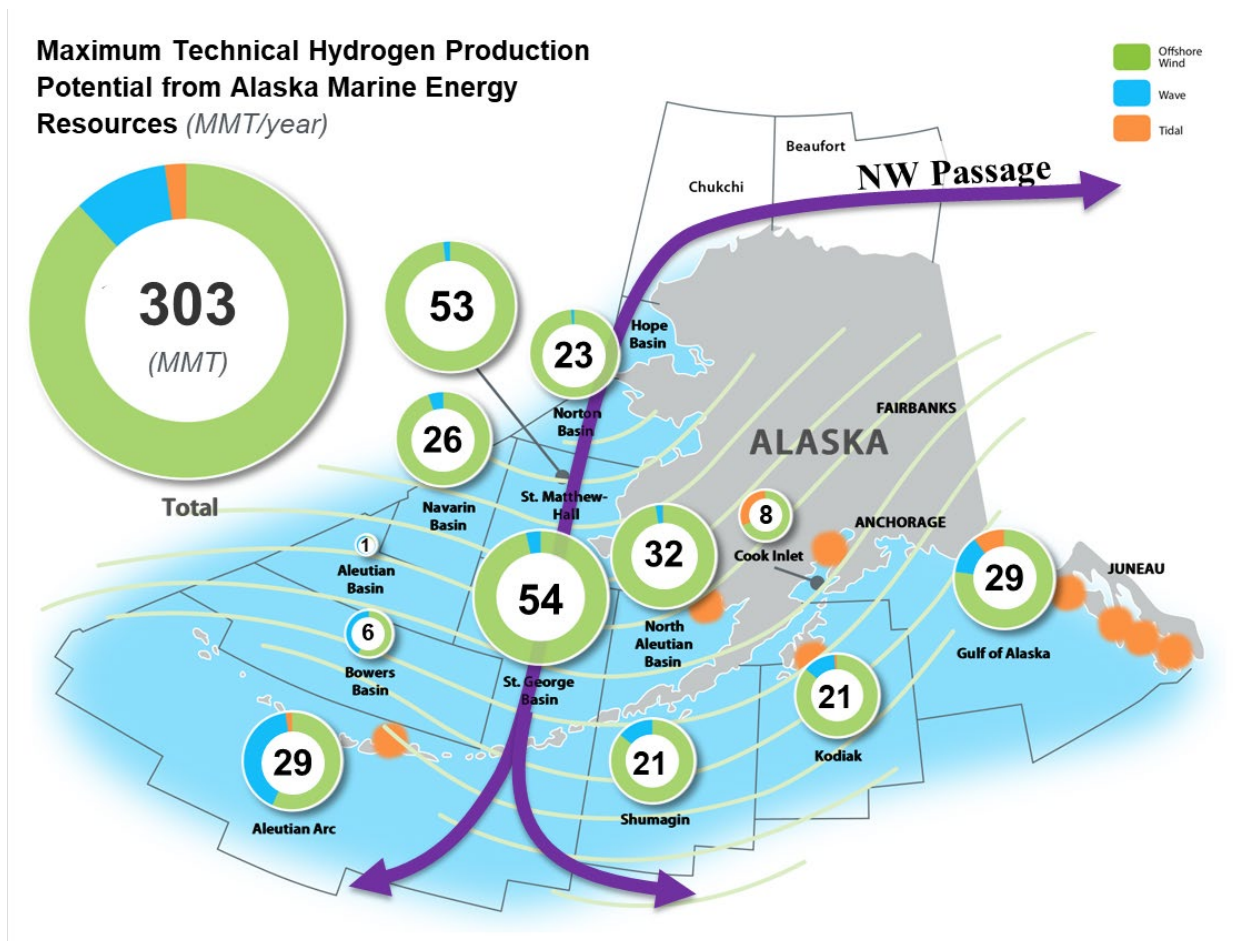

Figure 42. Maximum hydrogen production potential from Alaska marine energy resources
Values shown are in million metric tons (MMT) per year. Illustration by NREL

Clean hydrogen can be produced via many methods; however, the most commercially ready technology, provided the power source comes from renewable electricity, is through water electrolysis. With its performance characteristics and recent cost reductions, proton exchange membrane electrolyzers have surpassed available electrolyzer technologies (Plug 2022). This is the technology assumed in the analysis presented in the following subsections.

5.3.1 Methodology

The techno-economic assessment of hydrogen production and storage in Alaska was conducted using an open-source optimization framework called Revenue, Optimization, and Device Operation (RODeO, NREL 2022). RODeO is formulated as a mixed-integer linear programming model in the GAMS modeling platform (Best in class ... [date unknown]). The objective is to minimize the total unit cost for a collection of equipment at a given site. The equipment includes generators (e.g., gas turbine, steam turbine, solar, wind, hydro, fuel cells), storage systems (e.g., batteries, pumped storage hydropower, gas-fired compressed air energy storage, long-duration systems, hydrogen), and flexible loads (e.g., electric vehicles, electrolyzers, flexible building loads) (NREL 2020). Hence, the metric that is used for analysis and comparison of use cases in this analysis is levelized cost of hydrogen (LCOH). RODeO model inputs and outputs are shown in **Figure 43**.

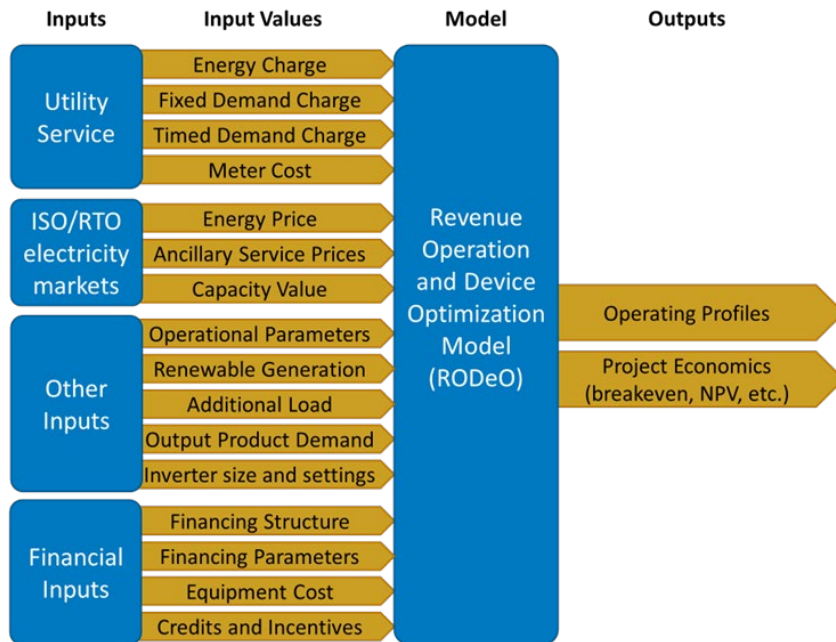
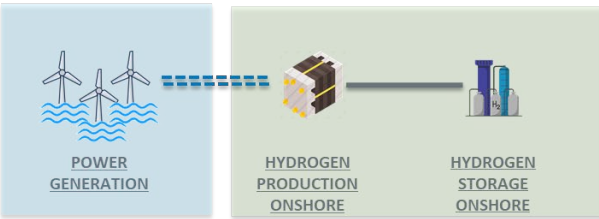

Figure 43. RODEO model inputs and outputs
 Source: Eichman et al. (2020)

5.3.2 Configurations and Locations

Two configurations with two variations each are illustrated in **Figure 44**. Offshore wind power is generated and sent to the electrolyzer, which can be located either on shore or on a platform offshore near the wind farm. In the case where the electrolyzer is located on shore, the cost for cabling and electricity losses are considered, whereas if the electrolyzer is located offshore, hydrogen pipeline costs to the storage location are considered. Storage types considered are compressed overground storage in type III tanks and geologic storage in depleted gas reservoirs. The storage type is decided based on the location and the available reservoirs close to the hydrogen generation site.

(a) Renewable offshore – H2 production onshore – compressed H2 storage



(b) Renewable offshore – H2 production offshore – compressed H2 storage

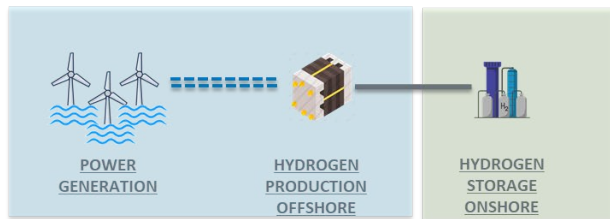

(c) Renewable offshore – H2 production onshore – geologic H2 storage

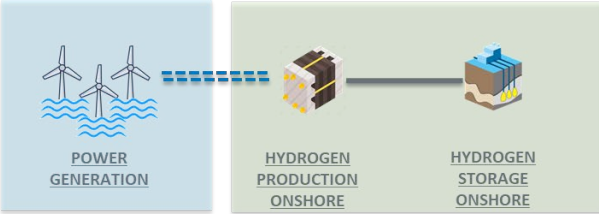

(d) Renewable offshore – H2 production offshore – geologic H2 storage

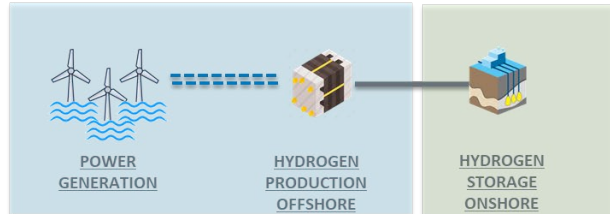

Figure 44. Configurations for this project

(a),(c) Illustration of a configuration of offshore wind resource and onshore electrolyzer with overground compressed hydrogen storage (a) and underground hydrogen storage (c). (b),(d) Illustrations of cases with offshore electrolyzers and hydrogen storage—overground (b) and underground (d) onshore. Illustration by NREL

Hydrogen production was considered across the four offshore wind case study locations (**Figures 45 and 46**). Potential hydrogen storage locations are marked, as are potential points where hydrogen demand could arise. For example, the Alaska Peninsula Eastern Aleutian case study location near Dutch Harbor is not close to any geologic storage, unlike the rest of the locations; hence, storage in pressurized vessels is considered. The potential demand for that location is fuel for fishing boats and ships. In the Western Alaska case study locations near Nome, potential demand could come from airports for sustainable aviation fuels from hydrogen and from ports for exports. The Homer and Nikiski area could use clean hydrogen for ammonia production, and for ports and airports for the same purpose as in the Western Alaska locations near Nome. In this analysis, hydrogen production is not tied to a particular demand type or amount. Further investigation will benefit the design and operation of end-to-end renewable hydrogen end-use systems. More discussion on what the current work results mean in the context of some potential future demand scenarios for Alaska can be found in the following subsections.

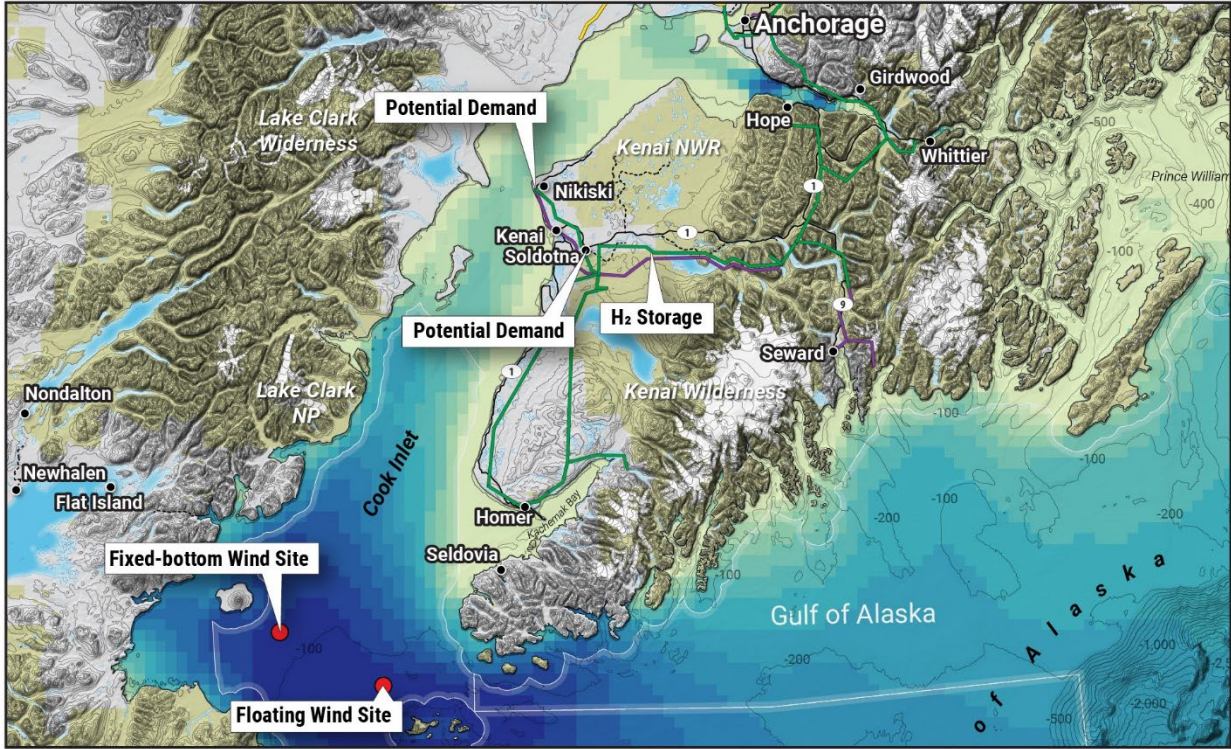

Figure 45. Hydrogen production locations and potential storage and demand locations: Southcentral Alaska (Lower Cook Inlet)
 Illustration by NREL

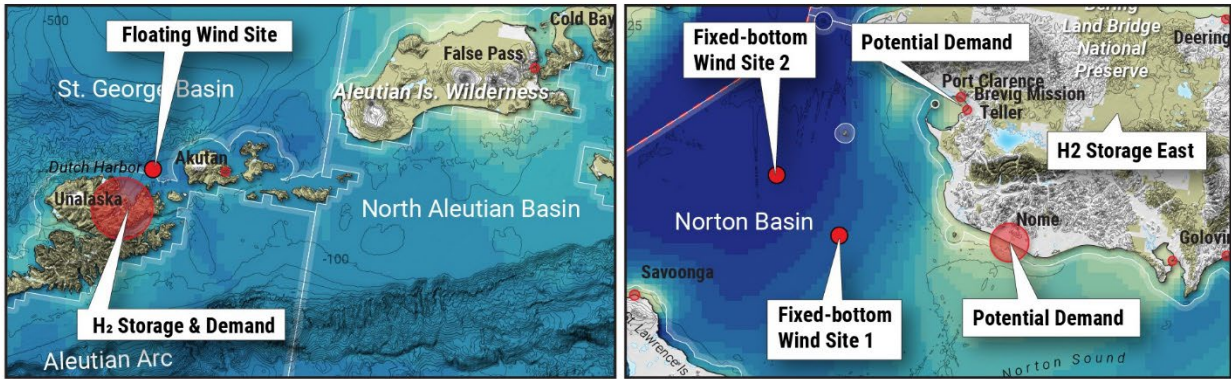

Figure 46. Hydrogen production locations and potential storage and demand locations: Alaska Peninsula and Eastern Aleutians (Dutch Harbor) and Western Alaska (Nome)
 Illustration by NREL

5.3.3 Techno-Economic Parameters

The major techno-economic assumptions, which were input to RODEO, are summarized in **Table 33**. The wind turbine farm has 1-GW capacity, and the capital and operating expenditures are the outputs of the analysis presented in Section 5.1. The electrolyzer cost is based on HFTO’s future targets (DOE 2023). The offshore electrolyzer assumes the technology is mounted on a platform, which doubles the cost if the electrolyzer were on shore. All locations except for Dutch Harbor assume depleted gas fields are available and could be repurposed to store hydrogen. The Dutch Harbor location uses overground compressed

hydrogen storage because there is no geologic storage nearby. Additionally, the hydrogen produced in that location is needed for shipping applications where liquid hydrogen predominates; hence, liquefaction cost is included. The total assumed losses are 20% with a breakdown of individual losses as shown in **Table 31**.

Table 31. Major assumptions used in the hydrogen techno-economic assessment of a 1-GW offshore wind farm

Component	Dutch Harbor	Cook Inlet Nikiski	Cook Inlet Homer	Nome 1	Nome 2
Wind turbine type	floating	floating	fixed-bottom	fixed-bottom	fixed-bottom
Wind CapEx with cabling costs (\$/kW)	\$4,661	\$5,385	\$4,292	\$4,980	\$5,397
Cabling CapEx (\$/kW)	\$91	\$459	\$255	\$360	\$503
Cabling installation (\$/kW)	\$9	\$57	\$31	\$31	\$45
Wind CapEx without cabling costs (\$/kW)	\$4,561	\$4,869	\$4,006	\$4,589	\$4,849
Wind OpEx (\$/kW-yr)	\$65	\$65	\$65	\$65	\$65
Onshore electrolyzer CapEx (\$/kW)	\$333	\$333	\$333	\$333	\$333
Offshore electrolyzer CapEx (\$/kW)*	\$665	\$665	\$665	\$665	\$665
Electrolyzer OpEx (\$/kW)	\$48	\$48	\$48	\$48	\$48
Type of storage	Overground compressed hydrogen	Depleted gas reservoir, Beaver Creek	Depleted gas reservoir, Beaver Creek	Depleted gas reservoir, West Fork	Depleted gas reservoir, West Fork
Distance to storage (km)**	0	224	192	126	176
Pipeline cost (\$M)	-	\$357.5	\$306.4	\$201.1	\$280.9
Liquefier (\$/kg H ₂)	\$1.61	N/A	N/A	N/A	N/A
Storage (\$/kg H ₂ stored)	\$718.20	\$1.8	\$1.8	\$1.8	\$1.8
Offshore wind average gross capacity factor (%)	64%	64%	64%	59%	62%
Loss assumptions (%)	20%	20%	20%	20%	20%

Source of data: Eichman (2020)

*Property tax benefits from locating electrolyzers in federal waters are reflected in the analysis.

**The authors acknowledge that the assumed distances for the Nome sites could be underestimated, and future studies will attempt to revise the numbers to more accurately represent the distances.

Additional assumptions include:

- Distance from electrolyzer to storage is approximate and represents a straight trajectory.
- Electrolyzer costs are based on DOE’s HFTO electrolyzer future targets (DOE 2023), which may or may not be met.
- Because of the uncertainty of locational hydrogen demand per application, we consider the total supply from all locations versus the total demand that is predicted in three scenarios: low, medium, and high. The scenarios and numbers are shown in the following subsection.
- It is assumed that a ratio of renewable-to-electrolyzer is 1:1, although previously it has been determined that most of the locations have an optimum ratio of 1:0.9, i.e., it is most economical to oversize the renewable plant. This is becoming a typical wind-hydrogen design.
- The selected year for the analysis (2035), is the commissioning year of the project.
- ITCs and PTCs for hydrogen and renewable energy are expected to have expired by 2035.
- The analysis in this section is a system-level techno-economic analysis and is used to provide some insight into the hydrogen production and storage costs in Alaska compared to various locations. To consider the entire techno-economic environmental-geopolitical picture, detailed designs and cost analyses need to be performed.

5.3.4 Results and Discussion

This section presents the main results for the 1-GW system, investigating how 2035 costs compare for different locations and onshore versus offshore electrolysis. We have also performed a sensitivity analysis on the wind capacity factors for the system.

5.3.4.1 Levelized Cost of Hydrogen

The breakdown of the LCOH in the year 2035 is shown in **Figure 47**. The LCOH varies between \$7/kg and \$11/kg H₂, depending on location. The most expensive site to produce hydrogen is Dutch Harbor because (1) liquefaction adds \$1.6/kg H₂ to the overall LCOH and (2) hydrogen storage and compression contribute ~\$1.2/kg H₂ to the total LCOH, which is about 13 times more than the contribution from salt caverns to other locations. As shown in the figure, the largest contributor to LCOH is the renewable capital cost portion. The lowest LCOH is for the Homer site (~\$7/kg H₂), which is due to the lowest LCOE and the potential to use geologic storage for the hydrogen.

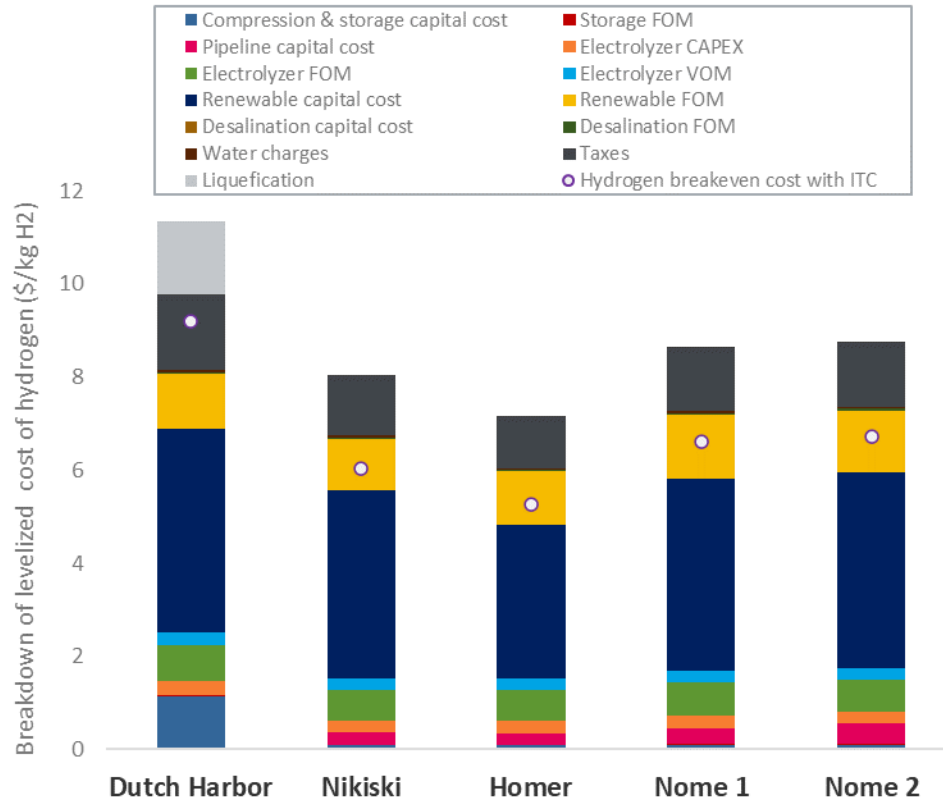

Figure 47. Levelized cost of hydrogen for Dutch Harbor, Nikiski, Homer, Nome 1, and Nome 2 locations for 2035

The configuration is for onshore electrolysis. VOM = variable O&M, FOM = fixed O&M.

In 2035, the ITC for hydrogen and renewable PTC will likely have expired; hence, the LCOH bars do not take them into account. If the tax credits are extended beyond 2035, however, the storage ITC could reduce LCOH by 7%–8%, and the two stacked PTCs by approximately \$1.4/kg H₂. Altogether, the credits can bring the LCOH down to ~\$5/kg–\$9/kg H₂. To reduce costs, the utilization factor of the electrolyzer could be increased by adding solar or other renewable power to the renewable mix. Other options for reducing the hydrogen cost are for the electrolyzer to participate in multiple uses to obtain additional revenues, the cost of offshore wind technologies to be further reduced, and the state to subsidize renewable energy on top of federal incentives.

For comparison, other studies (Ramadan et al. 2022) have examined the hydrogen production costs for Alaska and noted that the state ranks as one of the expensive states along with Hawaii, Rhode Island, and others, with an LCOH range of ~\$8/kg–\$14/kg H₂. When estimating how attractive hydrogen production potential is, not only is the levelized cost important but so is the willingness to pay. The U.S. National Clean Hydrogen Strategy and Roadmap (DOE 2023) provides a range of willingness to pay for hydrogen for its applications, varying from \$0.75/kg H₂ to \$7/kg H₂.

5.3.4.2 Offshore vs. Onshore Electrolyzer

Next, we compare the difference in LCOH when the electrolyzer is positioned onshore vs. offshore (Figure 48). As an example, the Dutch Harbor location is presented; however, the same dependency applies across all locations in that onshore electrolysis is slightly cheaper than offshore electrolysis. In the Alaska Peninsula Eastern Aleutian Dutch Harbor case study site, the difference is ~3%. Similar percent

values are expected for the remaining locations. The difference is in the cabling vs. pipeline costs, electrolyzer capital cost, and electricity losses resulting in lower hydrogen production. The percent value difference will differ with different cost assumptions, distances from the shore, and storage location, and further research is needed for the refinement of those differences.

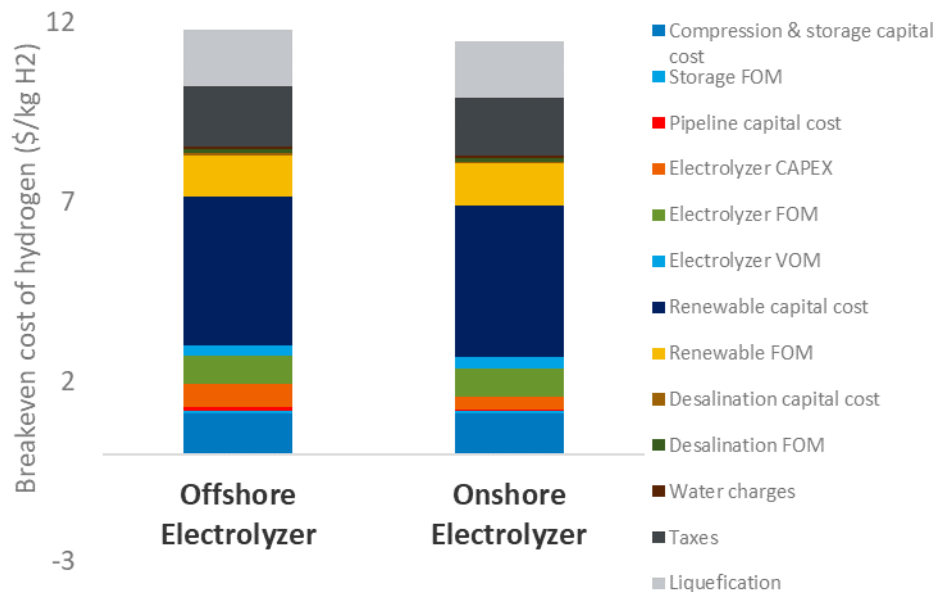

Figure 48. Comparison between LCOH with onshore and offshore electrolysis for Dutch Harbor

5.3.4.3 Results in the Context of Potential Hydrogen Demand Scenarios

To tackle the uncertainty of future hydrogen demand, we consider three possible scenarios in the state by 2035: conservative, mature markets, and optimistic (Figure 49). By 2035, hydrogen demand could be as much as 0.5 MMT, ~2 MMT, or ~3.8 MMT, depending on the scenario and assumptions. The major economic sectors in Alaska for which hydrogen could play a role in decarbonization are shipping, aviation fuel, ammonia production, energy storage, and exports to other countries.

The International Council on Clean Transportation identified that liquid hydrogen demand for shipping fuel in container ships, bulk carriers, vehicle carriers, oil tankers, and refrigerated and general cargo carriers could reach 0.01 MMT, 0.26 MMT, or 0.37 MMT by 2035 in the three scenarios (Georgeff et al. 2022). Countries that have stated they would import clean hydrogen (some provided by Alaska) are Japan (Reuters Staff 2020), South Korea (Australian Government 2022), and Germany (Radowitz 2022). Alaska could export enough hydrogen to meet 100% of the stated demand for Japan and South Korea, and 50% of the demand for Germany; however, Alaska may also not be able to export any hydrogen to Germany. Currently, 2 million gallons per day are used for aviation fuel in Alaska. If all that fuel was to be substituted with sustainable aviation fuels using hydrogen, ~0.4 MMT would be needed.

All five sites, with a 1-GW offshore wind plant and 1-GW electrolyzer capacity each, produce approximately 0.5 MMT hydrogen per year in total. This means that 0.5 MMT H₂ would be enough to meet the conservative scenario demand, 4 times the production would be needed to meet the realistic (“mature markets”) scenario, and ~8 times would be needed to meet the optimistic scenario.

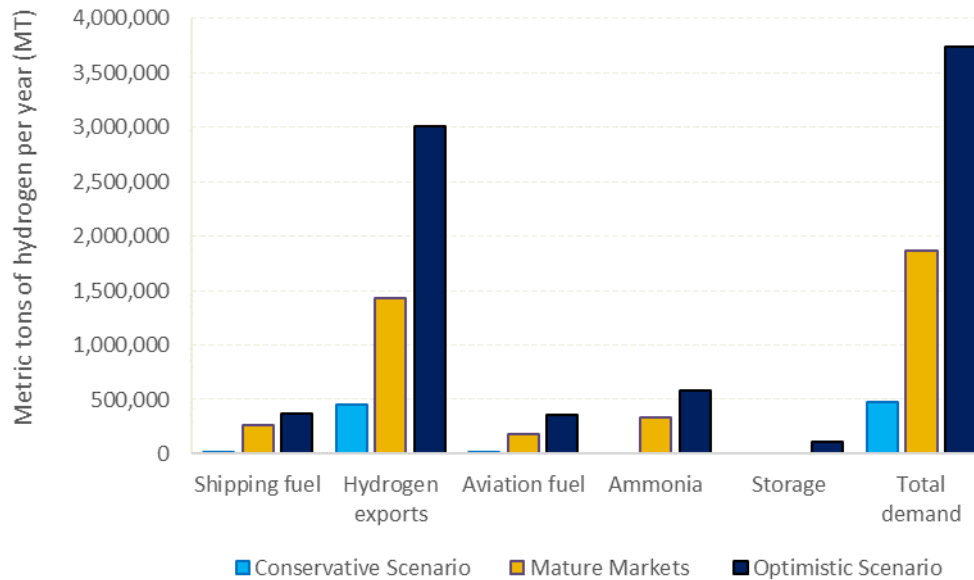

Figure 49. Potential hydrogen demand scenarios for Alaska by 2035 using conservative, medium, and optimistic scenarios

5.3.4.4 Recommendations and Next Steps

In summary, the hydrogen high-level techno-economic analysis results include: (1) Nikiski and Homer could be more beneficial for installing offshore renewable-hydrogen systems; (2) onshore electrolysis could marginally outperform offshore electrolysis; (3) LCOH is highly dependent on LCOE, and therefore reducing offshore wind cost would result in more competitive hydrogen costs.

Further, a more detailed analysis is needed to better understand when it would be most beneficial to build hydrogen systems, and which geographic locations (i.e., offshore, inland) and configurations (wind, solar, other renewables, electrolysis, electrolysis inside an offshore wind turbine structure, hybrid technologies, underwater hydrogen storage potential, etc.) could result in optimal designs with affordable hydrogen costs. The research space is still being developed, which gives BOEM an opportunity to form potential partnerships with the HFTO.

6 Stakeholder Engagement and Conflict Management

The objective of this section is to provide recommendations for stakeholder engagement and conflict management strategies tailored to support the establishment of BOEM’s renewable energy program for the Alaska OCS. This is not intended to be an exhaustive review of all possible processes for conflict management, but rather to provide an overview and some practical steps and strategies for BOEM.

NREL reviewed renewable energy conflict management strategies that have emerged in Alaska and worldwide to ensure that renewable energy does not unreasonably interfere with other uses of the OCS. NREL focused on strategies that are most amenable to Alaska conditions with close attention given to government-to-government and environmental justice considerations as well as workforce development needs to ensure sustainability of renewable energy projects. As with the case studies described in Section 4, the stakeholder engagement and conflict management strategies focus on the Alaska regions of Lower Cook Inlet, Dutch Harbor, and Nome.

6.1 Stakeholders

Developing a cohesive strategy for stakeholder engagement by identifying different stakeholder groups is an important first step. Alaska has more than 720,000 residents dispersed over 360 communities, with nearly half of its residents residing in the communities of Anchorage, Fairbanks, and Juneau (State of Alaska 2022). According to the 2022 Census update, 15.7% of Alaska’s general population is American Indian or Alaska Native (U.S. Census Bureau 2023). Alaska’s largest city, Anchorage, has the greatest proportion of Native peoples among places with over 100,000 residents, at 12% (Alaska native ... c2023).

To ensure broad representation from different stakeholder groups across Alaska, the NREL team worked with BOEM, a consultant to the Alaska Gasline Development Corporation, and NREL’s Applied Research for Communities in Extreme Environments to compile a list of stakeholders. Because the technologies presented in this report are all ocean-based, stakeholders are similar across technologies and locations (Figure 50).

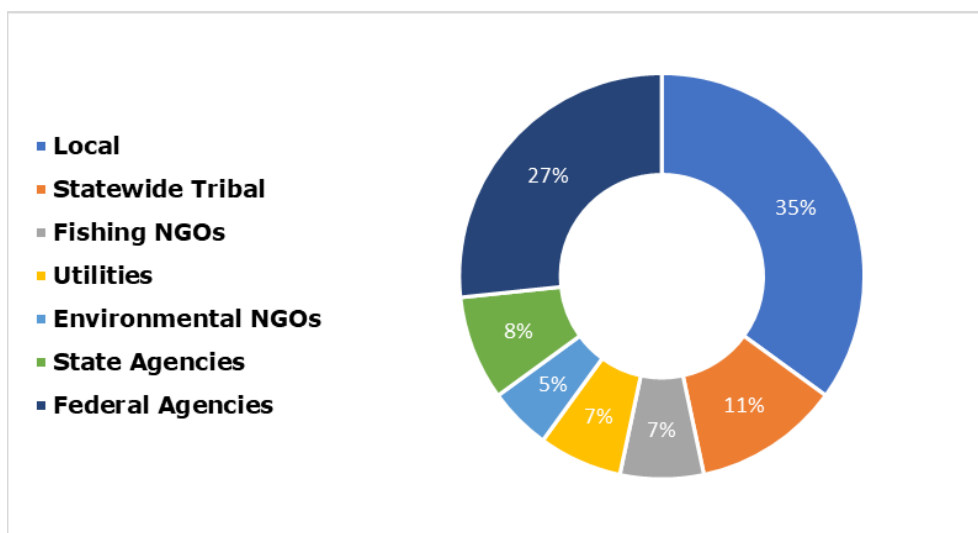

Figure 50. Alaska stakeholders for ocean-based renewable energy technologies
NGOs = nongovernmental organizations

Examining **Figure 50**, the bulk of the stakeholders are spread across three categories: local (municipal government, boroughs, community-based organizations), federal agencies (either as a regulator or landowner), and tribal governments and organizations. Below, NREL identifies relevant stakeholder groups for each location (**Table 32**).

Table 32. Stakeholder groups by location

Organization Name	Organization Type
Lower Cook Inlet	
Homer Municipal Government	Municipal
Kenai Peninsula Borough	Municipal
Port of Alaska	Municipal
Kenaitze Indian Tribe	Tribal
Salamatoff Native Association	Tribal
Ninilchik Traditional Council	Tribal
Cook Inlet Region, Inc	Tribal
Port Graham Tribal Council	Tribal
Native Village of Nanwalek	Tribal
Chugach Electric	Utility
Homer Electric Association	Utility
Cook Inlet Regional Citizens Advisory Council	Nongovernmental organization (NGO)
Cook Inletkeeper	NGO
Kenai River Sportfishing Association	NGO
United Cook Inlet Drifters Association	NGO
Northern District Set Netters of Cook Inlet	NGO
Cook Inlet Fisherman's Fund	NGO
North Pacific Fisheries Association	NGO
Cook Inlet Seiners Association	NGO
Dutch Harbor	
Unalaska Municipal Government	Municipal
Port of Dutch Harbor	Municipal
Qawalangin Tribe of Unalaska	Tribal
Bering Straits Native Corporation	Tribal
Aleut Corporation	Tribal
Unalaska Electric Power Generation Division	Utility
Nome	
Arctic Waterways Safety Committee	Municipal
Port of Nome	Municipal

Organization Name	Organization Type
Sitnasuak Native Corporation	Tribal
Nome Eskimo Community	Tribal
Kawerak, Inc	Tribal
Inuit Circumpolar Council	Tribal
Nome Joint Utilities System	Utility
Bering Sea Fisherman's Association	NGO
Statewide Tribal Organizations	
Alaska Native Tribal Health Consortium	Tribal
First Alaskans Institute	Tribal
Alaska Native Science Commission	Tribal
Indigenous People's Council for Marine Mammals	Tribal
Statewide Energy and Utility Organizations	
Alaska Center for Energy and Power	Research Institute
Pacific Marine Energy Center	Research Institute
Alaska Gasline Development Corporations	Public Corporation of the State of Alaska
Renewable Energy Alaska Project	NGO
Alaska Energy Authority	Public Corporation of the State of Alaska
Alaska Power Association	Trade Association
Railbelt Reliability Council	Electric Reliability Organization for Railbelt Certified by RCA
Regulatory Commission of Alaska	State Government
Statewide Commercial Fishing NGOs	
Alaska Fisherman's Network	NGO
Alaska Longline Fisherman's Association	NGO
Alaska Jig Association	NGO
United Fishermen of Alaska	NGO
Alaska Trollers Association	NGO
Yukon River Drainage Fisheries Association	NGO

Local, State, Federal, and Tribal Regulatory Agencies: Depending on the technology type, scale, and location, many federal agencies may be involved in authorizing offshore wind energy, marine energy, and clean hydrogen projects. With all regulatory authorizations, a high level of stakeholder involvement before the consultation process starts can be a key factor to successful project planning, siting, and execution. Strong coordination between project proponents, agency staff, and stakeholders can make the process more efficient for all parties.

Most renewable energy projects are developed in phases. The procedures for authorizing renewable energy projects typically involve environmental review and a substantial level of agency and stakeholder consultation. Complying with regulatory requirements can be time-consuming and expensive. By collaboratively discussing and addressing the issues associated with a proposed project, effective studying, monitoring, mitigation, and adaptive management measures can be developed and implemented throughout the project life cycle with support and concurrence from relevant stakeholders (Pacific Northwest National Laboratory 2020).

Table 33 summarizes the potential federal, tribal, state, and local entities that may be involved in authorizing projects in the OCS.

Table 33. Regulatory agencies involved in authorizing projects on the OCS

Agency	Offshore Wind	Marine Energy	Clean Hydrogen
Federal Energy Regulatory Commission	X (transmission)	X	X (pipeline)
Bureau of Ocean Energy Management	X (OCS)	X (OCS)	X (OCS)
U.S. Coast Guard	X	X	X
National Marine Fisheries Service	X	X	X
U.S. Fish and Wildlife Service	X	X	X
U.S. Environmental Protection Agency			X
U.S. Customs and Border Control	X (foreign vessel)	X (foreign vessel)	X (foreign vessel)
U.S. Department of the Interior, Bureau of Safety and Environmental Enforcement	X	X	X
Tribal Government Consultation	X	X	X
Sovereign tribes' rules and regulations	X (on tribal land)	X (on tribal land)	X (on tribal land)
State Historic Preservation Office	X (onshore)	X (onshore)	X (onshore)
Alaska Department of Fish and Game	X	X	X
Alaska Department of Natural Resources	X	X	X
Alaska Department of Environmental Conservation	X	X	X
Borough permits	X	X	X
Municipal permits	X	X	X

A proactive approach is needed to collaboratively discuss and address the issues associated with a proposed project in a government-to-government consultation context for federal agencies and tribal governments to work together to identify areas of tribal significance. Ball et al. (2015) recommended in a 2015 report that BOEM consider the following guidelines for building constructive relationships for meaningful and effective engagement, formal consultation, and collaboration with a tribal government during project authorization:

1. Background research
 - a. Research a tribe's culture
 - b. Research the history of the tribe and its current and historical relationship to the Federal government

- c. Understand what is and what is not appropriate within tribal culture
 - d. Understand the tribal perceptions of time and allow enough time to form ongoing relationships
2. Project planning
 - a. Budget resources and time for building relationships before decisions are made
 - b. Work toward building tribal capacity
 - c. Construct flexible protocols
 - d. Establish procedural neutrality when conducting meetings and workshops
 3. Consultation and collaboration
 - a. Understand tribal authority and representation
 - b. Respect tribal sovereignty, self-determination, and tribal protocols
 - c. Respect tribal interests and practices
 - d. Keep agency and tribal leadership apprised of developments
 - e. Adapt current information in light of new information received from tribes.

6.2 Energy Justice

Climate change can affect community resilience, infrastructure stability, and energy availability. This can put a strain on communities, their governments, and decision-makers (Kennedy et al. 2022). For many communities, access to resilient, affordable, sustainable, and clean energy resources are priorities, though historically, there have been disparities in the distribution of benefits and burdens of renewable energy systems. Resolving energy vulnerability in communities is key to mitigating the impacts of climate change. In Alaska, renewable energy projects in this report occur will occur on the ground and in the oceans surrounding communities. It is crucial that BOEM consider ways to bolster just and equitable approaches for energy transitions.

The following five concepts support more just and equitable energy transitions:

- Distributional justice seeks to ensure the fair distribution of benefits across the range of different users (Romero-Lankao and Nobler 2021).
- Procedural justice is equitable stakeholder involvement with an inclusive range of community groups and representatives in the decision-making process that leverages expertise and fills in the gaps in knowledge so that stakeholders can meaningfully participate (Ross and Day 2022).
- Recognition justice involves innovations and solutions that promote equity by addressing historic and ongoing inequalities (Romero-Lankao and Nobler 2021)
- Cosmopolitan justice focuses on the impact to historically excluded or underrepresented groups (Romero-Lankao and Nobler 2021).
- Restorative justice is the culmination of the above principles in practice (Ross and Day 2022).

Alaska communities—especially Alaska Native communities—face unique challenges associated with climate change. Native villages in Alaska disproportionately bear the brunt of cultural, economic, and environmental change (Alaska native ... c2023). Thawing permafrost threatens infrastructure, and rising sea levels and changing ecosystems threaten coastal communities, wildlife, and subsistence and commercial food sources. With the state of Alaska seeking to reduce reliance on fossil fuels by 2025 (Herrmann 2018), there is a pressing need to bolster just and equitable approaches for energy transitions within Alaska, especially tailored to Alaska Native peoples.

In addition to the five concepts of energy justice listed above, BOEM may also consider the following recommendations from Kennedy et al. (2022). The four recommendations below challenge the way Alaska Native community needs are typically considered in renewable energy projects. These recommendations address the need for community capacity-building as a prerequisite for achieving energy justice, which requires engaging Alaska Native communities earlier in the stakeholder outreach process.

- Supporting **training** is essential, along with improving working conditions for worker retention and fulfillment.
- Feasible **maintenance plans** that match community capacity are needed for all energy projects.
- **Educational initiatives** can boost community support of energy projects and engage multiple generations in creating energy futures.
- **Internet access** improvements should go together with energy development.

6.3 Recommended Stakeholder Engagement and Conflict Management Strategies

6.3.1 Stakeholder Engagement Strategies

After stakeholders are identified, they can be assessed based on their importance to and influence over the work. The desired contributions or roles of stakeholders can vary as the project progresses, and stakeholder engagement should be flexible to account for the waxing and waning of certain stakeholders over the life of a project. There are four levels of stakeholder engagement to consider for BOEM's renewable energy program for the Alaska OCS, and these levels are especially relevant to state and federal agencies, utilities, and NGOs:

1. **Inform.** Information is shared or outcomes are delivered to those it may affect.
2. **Consult.** These stakeholders provide opinions or information.
3. **Involve.** These stakeholders may provide resources or data in addition to opinions or information.
4. **Collaborate.** These stakeholders are effectively partners. They drive the direction of the project and contribute resources and direction (Durham et al. 2014).

An example of state and federal agencies, tribes, utilities, and NGO stakeholders based on levels of engagement is depicted in **Table 34**, adapted from Table 5.2 in *The BiodivERSA Stakeholder Engagement Handbook* (Durham et al. 2014).

Table 34. Examples of stakeholders and levels of engagement

Level of Engagement	Inform	Inform	Inform	Consult	Involve	Involve	Involve	Collaborate
Method of Engagement	Website	News-letter	Email	Survey	Work-shop	In-person Meetings	Virtual Meetings	Steering Group
Stakeholders								
Federal Agencies			X	X	X		X	X
State Agencies			X	X	X		X	
Tribal Entities	X	X	X	X	X	X	X	X
Utilities			X		X	X	X	
Fishing NGOs	X	X	X	X	X			
Environmental NGOs	X	X	X	X	X			

To build on the four levels of stakeholder engagement (inform, consult, involve, and collaborate) for stakeholder groups, BOEM may also want to consider deferring to communities, so that communities have ownership over outcomes of the project. Adapted from the work from Ross and Day (2022), where stakeholder engagement includes all of the following:

1. **Inform.** Information is shared or outcomes are delivered to those it may affect.
2. **Consult.** These stakeholders provide opinions or information.
3. **Involve.** Ensure community needs are integrated into process and inform planning.
4. **Collaborate.** Ensure community capacity to play a leadership role in implementation of decisions.
5. **Defer.** Foster democratic participation and equity through community-driven decision making (Gonzalez 2019, Ross and Day 2022).

6.3.2 Conflict Management Strategies

Alaska is a large state with a small population concentrated in Anchorage, Fairbanks, and Juneau. Alaska’s population has the highest percentage of American Indian or Alaska Native population of any state. The Alaska OCS supports numerous marine species, and those species contribute to a thriving commercial and subsistence fishing industry. Alaska communities and environments are especially vulnerable to climate change—the U.S. Department of Agriculture states that “due to its northern latitude and seasonal changes in sea ice, the state is warming at two to three times the rate of the global average. Rising temperatures can be tied to most of the effects of climate change in Alaska” (Alaska and a changing ... [date unknown]). Because of these unique attributes, it is important for decision-makers to bolster equitable approaches for renewable energy transitions.

The following stakeholder engagement strategies will help build collaborative relationships between BOEM and stakeholders:

- **Involve communities, collaborate with communities, and defer to communities** throughout the life of a project to bolster equitable approaches for energy transitions. NREL details

stakeholder engagement tactics that address the relationships between decision-makers and a variety of stakeholder groups.

- **Expand collaboration among industry, NGOs, community-based organizations, and regulatory agencies to allow better engagement with community stakeholders.** By collaboratively discussing and addressing the issues associated with a proposed project, effective studying, monitoring, mitigation, and adaptive management measures can be developed and implemented throughout the project with support from relevant stakeholders.
- **Consider a phased approach to new renewable technology projects and learn as technology grows.** When NREL presented proposed scenarios for developing offshore wind energy, marine energy, and clean hydrogen in the Alaska OCS at the 2023 Alaska Tribal Conference on Environmental Management, audience members expressed concern about the scale of the proposed projects. What looks financially feasible on paper may be perceived differently by other stakeholders.
- **Use baseline studies to measure and prioritize impacts to the environment.** Baseline studies provide a reference point for tracking project progress. This is especially important in a state where the harvest and processing of wild resources for food, raw materials, and cultural purposes have been a central part of the customs and traditions of many peoples in Alaska and such harvests are a strong underpinning of the economy.
- **Look at avoidance and mitigation options early in the consultation process and use adaptive management** if avoidance and mitigation tactics are not used. Adaptive management tests predictions against observations, which allows for iterative recalibration of the management process at predetermined decision points as learning occurs throughout the life of a project (Williams 2011).

7 Conclusions and Suggested Next Steps

Offshore wind is the most feasible option for renewable energy production in Alaska’s OCS in the next 10–20 years as compared to wave or tidal energy and remote clean hydrogen production. The technology is commercial, the estimated wind energy potential is substantial, and our LCOE estimates for all offshore wind case studies are lower than the LCOE of the tidal energy case study, though ocean energy project development scenarios in more remote locations like Dutch Harbor and Nome will require an alternative market (e.g., clean hydrogen) for project viability. The case studies in this report describe the challenges and opportunities of renewable energy projects in select regions of Alaska’s OCS. It would be prudent for BOEM to be prepared for possible future leasing of offshore wind in Cook Inlet as the market for renewable energy sources evolves over the next decade.

However, decision makers will need to compare these offshore wind costs to costs for utility-scale, land-based wind energy development to determine the best approach for full electrification (e.g., electric vehicles, heat pumps) of the Railbelt service area. To help provide this information, NREL is also finalizing an independent capacity expansion analysis (expected completion early 2024) of different renewable energy scenarios that could meet an 80% renewable portfolio standard on the Alaska Railbelt by 2040. The study seeks to identify the least-cost investment strategy for the Railbelt to reliably meet its electrical demand every year between now and 2040. The two Lower Cook Inlet offshore wind case studies in this report will potentially be the most cost-competitive compared to other energy generation options for Alaska. It would be useful to research the economic viability of smaller wind farms, curtailment, and quality of future wind scenarios in future analyses.

Alaska’s wave energy resource is significant but is generally far from any identifiable markets. Also, wave energy technologies are still in their early stages of development, with technology commercialization unlikely before 2035. However, wave energy is more predictable than other renewable energy resources—especially because wave energy resources can be estimated from satellite observations. We recommend that BOEM maintain current information about the development of these technologies—especially via communication with the U.S. Department of Energy’s Water Power Technologies Office—because if future technology advances are successful, wave energy could complement other variable power sources like wind and solar.

Tidal energy resources are relatively small compared to offshore wind and wave energy, and the technology is still in a precommercial state, but Alaska has some of the world’s best tidal resources. This superlative is generally accepted within the global industry and is based on the large quantity of resources located in Cook Inlet close to the Railbelt as well as the excellent resource quality based on high water current speeds, relatively unconflicted siting options,¹⁰ and the highly predictable and reliable nature of the resource. At present, the most promising sites for early tidal energy projects are in state waters, but as the technology matures and devices grow in size, Alaska’s OCS waters could become increasingly attractive for tidal energy development. NREL and the Alaska Center for Energy and Power are in the process of finalizing a road map for developing tidal energy projects in Cook Inlet (expected completion early 2024). That road map shows that the critical next step for tidal energy development in Alaska is to execute technology demonstration projects (i.e., <1 MW) that are designed to identify which technologies

¹⁰ Tidal energy devices in Cook Inlet can be submerged to depths below where they would interfere with maritime navigation, and because Cook Inlet is very large relative to the energy that would be extracted, the impacts to currents and tides would be negligible. As they would not be visible from the surface, tidal energy devices may have lower social acceptance and permitting barriers compared to large wind projects above the water.

work in Alaska waters. This is also likely to involve modifying or refining existing designs to make them robust enough for Alaska conditions (e.g., ice and sediment). We recommend that BOEM continue to stay involved with working groups focused on tidal energy and stay educated about the progress of demonstration projects so that they are prepared to review applications to develop commercial projects when the time comes.

As the immense ocean-based resources could enable electricity production greater than the capacity of the Railbelt, clean hydrogen is one option that can create a parallel path to serve other end uses. Longer-term advances in hydrogen technology may create demand for the development of more remote offshore wind farms to serve a hydrogen export market in or outside of Alaska by 2040. End uses for clean hydrogen statewide were identified and estimated to range from 4,800 to 83,000 GWh annually. For more information on hydrogen market potential in Alaska, BOEM could consult the DOE Arctic Energy Office's *Alaska Hydrogen Opportunities Report*, which was under production at the time of the writing of this report. The levelized cost of hydrogen is highly dependent on the source electricity LCOE; therefore, driving down those costs (i.e., offshore wind) would result in more competitive hydrogen costs, which could in turn drive the hydrogen market potential.

Other possibilities also exist for monetizing the energy produced, including the development of local infrastructure for mineral smelting, seawater mining, aquaculture, marine carbon dioxide removal, fish processing, data centers, or the production of some other industrial or agricultural product (e.g., urea) with high electricity demand.

BOEM Alaska should assemble a task force and/or an ocean energy developer's forum to share the information collected and assess interest in demonstrating ocean energy potential through a pilot study or by supporting other critical research initiatives. There could also be value for BOEM in strengthening ocean energy-related partnerships with the U.S. Department of Energy's Arctic Energy Office, Water Power Technologies Office, and Hydrogen and Fuel Cell Technologies Office

8 References

- About the Power Cost Equalization program. c2023. Anchorage, AK: Alaska Energy Authority; [accessed 2023 Nov 3]. <https://www.akenergyauthority.org/What-We-Do/Power-Cost-Equalization>.
- Alaska Airlines. 2022 Aug. 3. Alaska Airlines makes significant investment in sustainable aviation fuel [article]. Cision PR Newswire; [accessed 2023 Nov 3]. <https://www.prnewswire.com/news-releases/alaska-airlines-makes-significant-investment-in-sustainable-aviation-fuel-301598658.html>.
- Alaska and a changing climate. [date unknown]. U.S. Department of Agriculture Climate Hubs; [accessed 2023 Nov 3]. <https://www.climatehubs.usda.gov/hubs/northwest/topic/alaska-and-changing-climate>.
- Alaska Energy Authority. 2019. Statistical report of the Power Cost Equalization program: fiscal year 2018, July 1, 2017–June 30, 2018, thirtieth edition. Anchorage, AK: Alaska Energy Authority. 29 p.
- Alaska native peoples. c2023. Anchorage, AK: Alaska Federation of Natives; [accessed 2023 Nov 3]. <https://www.nativefederation.org/alaska-native-peoples/>.
- Alaska’s Arctic deep draft port at Nome. [date unknown]. Nome, AK: Port of Nome; [accessed 2023 Nov 3]. <https://www.nomealaska.org/port-nome>.
- Alaska’s fishing industry. [date unknown]. Anchorage, AK: Resource Development Council for Alaska, Inc.; [accessed 2023 Nov 3]. <https://www.akrdc.org/fisheries>.
- Allen R, Brutkoski D, Farnsworth D, Larsen P. 2016. Sustainable energy solutions for rural Alaska. Berkeley, CA: Lawrence Berkeley National Laboratory. 79 p. Report No. LBNL-1005097.
- ARUP. 2020. Crown Estate Scotland: Ports for offshore wind: a review of the net-zero opportunity for ports in Scotland. Glasgow, UK: ARUP. 76 p.
- ARUP. 2022. Assessment of electrolysers: final report. Edinburgh, Scotland: Ove Arup & Partners Limited. 62 p.
- Australian Government, Australian Trade and Investment Commission. 2022. Korean hydrogen market update. 20 p.
- Baca E, Philip RT, Greene D, Battey H. 2022. Expert elicitation for wave energy LCOE futures. Golden, CO: National Renewable Energy Laboratory. 27 p. NREL/TP-5700-82375.
- Ball D, Clayburn R, Cordero R, Edwards B, Grussing V, Ledford J, McConnell R, Monette R, Steelquist R, Thorsgard E, Townsend J. 2015. A guidance document for characterizing tribal cultural landscapes. U.S. Department of the Interior, Bureau of Ocean Energy Management, Pacific OCS Region, Camarillo, CA. OCS Study BOEM 2015-0477. 32 p.
- Beiter P, Musial W, Smith A, Kilcher L, Damiani R, Maness M, Sirnivas S, Stehly T, Gevorgian V, Mooney M, George S. 2016. A spatial-economic cost-reduction pathway analysis for U.S. offshore wind energy development from 2015–2030. Golden, CO: National Renewable Energy Laboratory. 214 p. Report No. NREL/TP-6A20-66579.
- Best in class mathematical modeling. Performant, scalable, easy to learn. [date unknown]. GAMS; [accessed 2023 Nov 3]. <https://www.gams.com/>.

- Cicilio P, Francisco A, Morelli C, Wilber M, Pike C, VanderMeer J, Colt S, Pride D, Helder N. 2023. Load, electrification adoption, and behind-the-meter solar forecasts for Alaska’s Railbelt transmission system. *Energies*. 16:6117.
- Commercial fisheries overview: Bering Sea & Aleutian Islands management area. [date unknown]. Juneau (AK): Alaska Department of Fish and Game; [accessed 2023 Nov 3]. <https://www.adfg.alaska.gov/index.cfm?adfg=commercialbyareaaleutianislands.main>.
- Commercial fisheries overview: Cook Inlet management area. [date unknown]. Juneau (AK): Alaska Department of Fish and Game; [accessed 2023 Nov 3]. <https://www.adfg.alaska.gov/index.cfm?adfg=commercialbyareacookinlet.main>.
- Commercial fisheries overview: Norton Sound & Kotzebue management area. [date unknown]. Juneau (AK): Alaska Department of Fish and Game; [accessed 2023 Nov 3]. <https://www.adfg.alaska.gov/index.cfm?adfg=commercialbyareanortonsound.main>.
- Cook Inlet Gas Supply. c2023. Enstar Natural Gas Company; [accessed 2023 Oct 5]. <https://www.enstarnaturalgas.com/cook-inlet-gas-supply/>.
- Critical habitat. [date unknown]. U.S. Fish & Wildlife Service; [accessed 2023 Nov 3]. <https://www.fws.gov/project/critical-habitat>.
- Denholm P, Schwarz M, DeGeorge E, Stout S, Wiltse N. 2022. Renewable portfolio standard assessment for Alaska’s Railbelt. Golden, CO: National Renewable Energy Laboratory. 51 p. Report No. NREL/TP-5700-81698.
- [DOE] U.S. Department of Energy. 2023. U.S. national clean hydrogen strategy and roadmap. Washington, D.C.: U.S. Department of Energy. 99 p.
- DOE Office of Policy. 2022. The Inflation Reduction Act drives significant emissions reductions and positions America to reach our climate goals. Washington, D.C.: U.S. Department of Energy. 6 p. Report No. DOE/OP-0018.
- Doubrawa P, Scott G, Musial W, Kilcher L, Draxl C, Lantz E. 2017. Offshore wind energy resource assessment for Alaska. Golden, CO: National Renewable Energy Laboratory. 39 p. Report No. NREL/TP-5000-70553.
- Durham E, Baker H, Smith M, Moore E, Morgan V. 2014. The BiodivERsA stakeholder engagement handbook. Paris, France: BiodivERsA. 108 p.
- Dutch Harbor. [date unknown]. Ketchikan, AK: Alaska Marine Highway System; [accessed 2023 Nov 3]. <https://dot.alaska.gov/amhs/comm/unalaska.shtml>.
- [EIA] U.S. Energy Information Administration. 2022a. Alaska electricity profile 2021. Washington, D.C.: U.S. Energy Information Administration; [accessed 2022 May]. <https://www.eia.gov/electricity/state/alaska/>.
- EIA. 2022b. Alaska state profile and energy estimates – profile data. Washington, D.C.: U.S. Energy Information Administration; [accessed 2023 Nov 3]. <https://www.eia.gov/state/data.php?sid=AK>.

- EIA. 2023a. Alaska state profile and energy estimates – profile analysis.” Washington, D.C.: U.S. Energy Information Administration; [accessed 2023 Nov 3]. <https://www.eia.gov/state/analysis.php?sid=AK>.
- EIA. 2023b. Electricity explained: electricity generation, capacity, and sales in the United States. Washington, D.C.: U.S. Energy Information Administration; [accessed 2023 Nov 3]. <https://www.eia.gov/energyexplained/electricity/electricity-in-the-us-generation-capacity-and-sales.php>.
- Eichman J, Koleva M, Guerra OJ, McLaughlin B. 2020. Optimizing an integrated renewable-electrolysis system. Golden, CO: National Renewable Energy Laboratory. 68 p. Report No. NREL/TP-5400-75635.
- Electricity rates in Alaska: electricity rates, plans & statistics. 2022. Find Energy; [accessed 2023 Nov 3]. <https://findenergy.com/ak/>.
- Expertise for the hydrogen age. c2023. Fraunhofer; [accessed 2023 Nov 3]. <https://www.fraunhofer.de/en/research/current-research/hydrogen/vom-material-zum-system.html>.
- Federal special status species: federal endangered species. [date unknown]. Juneau (AK): Alaska Department of Fish and Game; [accessed 2023 Nov 3]. <https://www.adfg.alaska.gov/index.cfm?adfg=specialstatus.fedendangered>.
- Funding notice: \$45 million funding opportunity will advance tidal and current energy development and drive U.S. leadership in the sector. 2023. Washington, D.C.: U.S. Department of Energy Water Power Technologies Office; [accessed 2023 Nov 3]. <https://www.energy.gov/eere/water/funding-notice-45-million-funding-opportunity-will-advance-tidal-and-current-energy>.
- Gaertner E, Rinker J, Sethuraman L, Zahle F, Anderson B, Barter G, Abbas N, et al. 2020. Definition of the IEA Wind 15-megawatt offshore reference wind turbine. Golden, CO: National Renewable Energy Laboratory. 54 p. Report No. NREL/TP-5000-75698.
- Geography of Alaska. [date unknown]. State of Alaska; [accessed 2023 Nov 3]. <https://alaska.gov/Kids/learn/aboutgeography.htm>.
- Georgeff E, Mao X, Rutherford D. 2022. Scaling U.S. zero-emission shipping: potential hydrogen demand at Aleutian Islands ports. The International Council on Clean Transportation. Working paper 2022-21.
- Gonzalez R. 2019. The spectrum of community engagement to ownership. Facilitating Power; [accessed 2023 Nov 3]. <https://movementstrategy.org/resources/the-spectrum-of-community-engagement-to-ownership/>.
- Haas KA, Fritz HM, French SP, Smith BT, Neary V. 2011. Assessment of energy production potential from tidal streams in the United States: final project report. Georgia Tech Research Corporation. 109 p.
- Herrmann V. 2018 Nov. 13. Breaking free: Alaska’s path forward for renewable arctic energy [article]. The Arctic Institute; [accessed 2023 Nov 3]. <https://www.thearcticinstitute.org/breaking-free-alaskas-path-forward-renewable-arctic-energy/>.

- Hydrogen shot. [date unknown]. Washington, D.C.: U.S. Department of Energy Hydrogen and Fuel Cell Technologies Office; [accessed 2023 Nov 3]. <https://www.energy.gov/eere/fuelcells/hydrogen-shot>.
- International Electrotechnical Commission. 2020. Marine energy - wave, tidal and other water current converters - Part 1: Vocabulary. IEC TS 62600-1:2020.
- Janssen D, Simon F. 2020 Sept. 3. IRENA chief: Europe is ‘the frontrunner’ on tidal and wave energy [article]. Euractiv; [accessed 2023 Nov 3]. <https://www.euractiv.com/section/energy/interview/irena-chief-europe-is-the-frontrunner-on-tidal-and-wave-energy/>.
- Jenne S, Baca E. 2019. MHK levelized cost of energy (LCOE) guidance and techno economic analysis materials [dataset]. Golden, CO: National Renewable Energy Laboratory; [accessed 2023 Nov 3]. <https://dx.doi.org/10.15473/1700651>.
- Kennedy EP, Moore SK, Puente FY, Whittle-Walls GK, Day JT. 2022. Understanding energy justice needs among Alaska Native communities in the transition to clean energy: a framework for conducting energy justice assessments. Richland, WA: Pacific Northwest National Laboratory.
- Kilcher L, Fogarty M, Lawson M. 2021. Marine energy in the United States: an overview of opportunities. Golden, CO: National Renewable Energy Laboratory. 48 p. Report No. NREL/TP-5700-78773.
- Kilcher L, García Medina G, Yang Z. 2023. A scalable wave resource assessment methodology: application to U.S. waters. *Renewable Energy* 217:119094.
- Kilcher L, Thresher R, Tinneland H. 2016. Marine hydrokinetic energy site identification and ranking methodology part II: tidal energy. Golden, CO: National Renewable Energy Laboratory. 30 p. Report No. NREL/TP-5000-66079.
- Kilcher L, Thresher R. 2016. Marine hydrokinetic energy site identification and ranking methodology part I: wave energy. Golden, CO: National Renewable Energy Laboratory. 38 p. Report No. NREL/TP-5000-66038.
- Kohler M, Schutt E. 2012. Energy for a sustainable Alaska: the rural conundrum. Anchorage, AK: Commonwealth North. 42 p. <https://www.denali.gov/wp-content/uploads/2018/10/CWN-Report-Energy-for-a-Sustainable-Alaska-The-Rural-Conundrum1.pdf>.
- Lawrence Livermore National Laboratory. 2023. Energy flow charts. LLNL.gov. <https://flowcharts.llnl.gov/commodities>. Creative Commons license CC BY-NC-SA 4.0 (<https://creativecommons.org/licenses/by-nc-sa/4.0/>).
- Lazard. 2023. LCOE+. Lazard. 57 p. [accessed 2023 Nov 3]. <https://www.lazard.com/media/nltb551p/lazards-lcoeplus-april-2023.pdf>.
- Lee JA, Doubrawa P, Xue L, Newman AJ, Draxl C, Scott G. 2019. Wind resource assessment for Alaska’s offshore regions: validation of a 14-year high-resolution WRF data set. *Energies* 12(14):2780.
- McDowell Group. 2016. Southeast Alaska energy update and profile. Juneau and Anchorage, AK: McDowell Group. 114 p.

- Musial W, Heimiller D, Beiter P, Scott G, Draxl C. 2016. 2016 offshore wind energy resource assessment for the United States. Golden, CO: National Renewable Energy Laboratory. 88 p. Report No. NREL/TP-5000-66599.
- Musial W, Spitsen P, Duffy P, Beiter P, Marquis M, Hammond R, Shields M. 2022. Offshore wind market report: 2022 edition. Washington, D.C.: U.S. Department of Energy. 126 p. Report No. DOE/GO-102022-5765.
- Musial W, Spitsen P, Duffy P, Beiter P, Shields M, Hernando DM, Hammond R, Marquis M, King J, Sathish S. 2023. Offshore wind market report: 2023 edition. Washington, D.C.: U.S. Department of Energy. 141 p. Report No. DOE/GO-102023-6059.
- Nearly V, Previsic M, Jepsen R, Lawson M, Yu Y, Copping A, Fontaine A, Hallett K, Murray D. 2014. Methodology for design and economic analysis of marine energy conversion (MEC) technologies. Albuquerque, NM: Sandia National Laboratories. 262 p. Report No. SAND2014-9040.
- [NREL] National Renewable Energy Laboratory. 2020. RODEO [dataset]. Golden, CO: National Renewable Energy Laboratory; [accessed 2023 Nov 3]. <https://github.com/NREL/RODeO>.
- NREL. 2022. Annual technology baseline [dataset]. Golden, CO: National Renewable Energy Laboratory; [accessed 2023 Nov 3]. <https://atb.nrel.gov/>.
- Nunemaker J, Shields M, Hammond R, Duffy P. 2020. ORBIT: offshore renewables balance-of-system and installation tool. Golden, CO: National Renewable Energy Laboratory. 56 p. Report No. NREL/TP-5000-77081.
- Pacific Northwest National Laboratory. 2020. Handbook of marine hydrokinetic regulatory processes. Washington, D.C.: U.S. Department of Energy Water Power Technologies Office. 130 p. Report No. DOE-EE-1793.
- Parkison SB, Kempton W. 2022. Marshaling ports required to meet US policy targets for offshore wind power. *Energy Policy* 163(April):112817.
- Plug. 2022 July 6. Between two stacks: how a PEM electrolyzer is more cost-effective than an alkaline electrolyzer [blog]. Plug Power Inc.; [accessed 2023 Nov 3]. <https://www.plugpower.com/between-two-stacks-how-a-pem-electrolyzer-is-more-cost-effective-than-an-alkaline-electrolyzer/>.
- Port of Alaska in Anchorage. c2023. Anchorage, AK: Port of Alaska; [accessed 2023 Nov 3]. <https://www.portofalaska.com/>.
- Port of Nome modification, Nome, Alaska, public meeting. 2023. Nome, AK: Port of Nome; [accessed 2023 Nov 3]. https://www.nomealaska.org/sites/default/files/fileattachments/port_of_nome/page/11929/ponm_phase_1_public_information_meeting_2.0_20230517.pdf.
- Previsic M, Bedard R. 2009. Yakutat conceptual design, performance, cost and economic wave power feasibility study. Electric Power Research Institute. 43 p. Report No. EPRI-WP-006-Alaska.
- PRIMRE: basics: current energy. 2023. Golden, CO: National Renewable Energy Laboratory; [updated 2023 Nov 2; accessed 2023 Nov 3]. https://openei.org/wiki/PRIMRE/Basics/Current_Energy.

- Project description – Makushin geothermal project (Unalaska, Alaska). c2020. Chena Power; [accessed 2023 Nov 3]. <https://www.alaskageothermal.info/project>.
- Radowitz B. 2022 March 21. Germany plans to import hydrogen from UAE using ‘liquid organic carrier’ technology [article]. Recharge; [accessed 2023 Nov 3]. <https://www.rechargenews.com/energy-transition/germany-plans-to-import-hydrogen-from-uae-using-liquid-organic-carrier-technology/2-1-1188575>.
- Ramadan MM, Wang Y, Tooteja P. 2022. Analysis of hydrogen production costs across the United States and over the next 30 years (Preprint). arXiv:2206.10689v2. 16 p. [accessed 2023 Nov 3]. <https://doi.org/10.48550/arXiv.2206.10689>.
- Regional clean hydrogen hubs. [date unknown]. U.S. Department of Energy Office of Energy Efficiency and Renewable Energy; [accessed 2023 Nov 3]. <https://afdc.energy.gov/laws/13033>.
- Reuters Staff. 2020 Oct. 15. Japan aims to set up commercial hydrogen fuel supply chain by 2030 [article]. Reuters; [accessed 2023 Nov 3]. <https://www.reuters.com/article/us-japan-energy-hydrogen/japan-aims-to-set-up-commercial-hydrogen-fuel-supply-chain-by-2030-idUSKBN2700PM>.
- Rezal A. 2021 Nov. 26. Where most Native Americans live. U.S. News & World Report; [accessed 2023 Oct 5]. <https://www.usnews.com/news/best-states/articles/the-states-where-the-most-native-americans-live#:~:text=Native%20Americans%20account%20for%20more.and%20New%20Mexico%20with%2012%25>.
- NovRomero-Lankao P, Nobler E. 2021. Energy justice: key concepts and metrics relevant to EERE transportation projects. Golden, CO: National Renewable Energy Laboratory. 15 p. Report No. NREL/TP-5400-80206.
- Ross L, Day M. 2022. Community energy planning: best practices and lessons learned in NREL’s work with communities. Golden, CO: National Renewable Energy Laboratory. 16 p. Report No. NREL/TP-6A50-82937.
- Shields M, Beiter P, Nunemaker J. 2022. A systematic framework for projecting the future cost of offshore wind energy. Golden, CO: National Renewable Energy Laboratory. 32 p. Report No. NREL/TP-5000-81819.
- Shields M, Cooperman A, Kreider M, Oteri F, Hemez Z, Gill L, Sharma A, Fan K, Musial W, Trowbridge M, et al. 2023. The impacts of developing a port network for floating offshore wind energy on the west coast of the United States. Golden, CO: National Renewable Energy Laboratory. 169 p. Report No. NREL/TP-5000-86864.
- State of Alaska. 2022. Open Data Geoportal, DCCED certified population counts (all locations) [dataset]. State of Alaska; [accessed 2023 Nov 3]. <https://gis.data.alaska.gov/datasets/DCCED::dcced-certified-population-counts-all-locations/about>.
- Stehly T, Duffy P. 2022. 2020 cost of wind energy review. Golden, CO: National Renewable Energy Laboratory. 77 p. Report No. NREL/TP-5000-81209.
- Subsistence fishing. [date unknown]. Juneau (AK): Alaska Department of Fish and Game; [accessed 2023 Nov 3]. <https://www.adfg.alaska.gov/index.cfm?adfg=fishingSubsistence.main>.

- Subsistence in Alaska: overview: definition, responsibilities and management. [date unknown]. Juneau (AK): Alaska Department of Fish and Game; [accessed 2023 Nov 3]. <https://www.adfg.alaska.gov/index.cfm?adfg=subsistence.definition>.
- System Advisor Model Version 2022.11.29 (SAM 2022.11.21). 2022. Golden, CO: National Renewable Energy Laboratory. <https://https://sam.nrel.gov>.
- U.S. Census Bureau. 2023. City and town population totals: 2020–2022. [accessed 2023 Oct 4]. <https://www.census.gov/data/tables/time-series/demo/popest/2020s-total-cities-and-towns.html>.
- Unalaska marine center (UMC) and the USCG dock. [date unknown]. Unalaska, AK: City of Unalaska; [accessed 2023 Nov 3]. <https://www.ci.unalaska.ak.us/portsandharbors/page/unalaska-marine-center-umc-and-uscg-dock>.
- What are technology readiness levels (TRL)? c2023. Cambridge, UK: TWI; [accessed 2023 Nov 3]. <https://www.twi-global.com/technical-knowledge/faqs/technology-readiness-levels>.
- Wildlife. [date unknown]. Unalaska, AK: City of Unalaska; [accessed 2023 Nov 3]. <https://www.ci.unalaska.ak.us/community/page/wildlife>.
- Williams BK. 2011. Passive and active adaptive management: approaches and an example. *J. Environ. Manage.* 92(5):1371–1378.
- Wiser R, Rand J, Seel J, Beiter P, Baker E, Lantz E, Gilman P. 2021. Expert elicitation survey predicts 37% to 49% declines in wind energy costs by 2050. *Nat. Energy.* 6:555–565.
- Yang S, Lassen S, Liu D. 2019. Offshore Wind Operations and Maintenance Trends. Wood Mackenzie Power & Renewables.

Appendix A: Community Distance to Nearest Offshore Wind Resource

Table A-1 lists the distance of communities to the nearest offshore wind resource from the technical potential analysis, separated into land and water distance, and reporting the wind speed value of the closest resource. The distance was computed with GIS software utilizing the Alaska Albers Equal Area projection, NAD83 datum.

Table A-1. Community distance to nearest offshore wind resource

ID	Community	Total Distance to Resource (km)	Land Distance (km)	Water distance (km)	Closest 100-m wind speed from technical potential (m/s)
2	Akhiok	155.49	129.48	26.01	9.03
3	Akiachak	18.37	7.12	11.25	8.13
4	Akiak	125.53	115.80	9.73	8.13
6	Alakanuk	129.99	121.75	8.24	7.93
8	Alcan Border	15.41	11.36	4.04	8.09
9	Aleknagik	304.88	299.49	5.39	8.56
10	Aleneva	78.07	71.06	7.01	9.01
12	Ambler	30.42	23.43	6.99	7.34
14	Anchor Point	346.97	303.57	43.40	7.29
	Anchorage	11.55	2.13	9.43	7.22
32	Anderson	477.71	434.58	43.12	7.81
33	Angoon	52.75	32.59	20.16	7.06
34	Aniak	240.61	235.37	5.24	8.13
35	Anvik	127.85	106.64	21.20	7.05
38	Atmautluak	109.60	85.76	23.84	8.47
41	Badger	506.61	468.02	38.59	7.81
44	Bear Creek	35.33	21.42	13.91	7.22
46	Beluga	111.35	12.96	98.39	7.38
47	Bethel	108.36	96.80	11.56	8.13
49	Big Delta	429.24	395.16	34.07	7.81
50	Big Lake	181.62	45.40	136.22	7.38
53	Buckland	171.43	151.89	19.54	7.73
54	Buffalo Soapstone	204.98	182.70	22.28	7.22
55	Butte	185.56	165.49	20.07	7.22
56	Cantwell	375.09	320.14	54.95	7.81
57	Central	590.80	567.45	23.35	7.9
59	Chase	264.85	179.81	85.05	7.38
60	Chefornak	12.06	10.96	1.10	8.27

ID	Community	Total Distance to Resource (km)	Land Distance (km)	Water distance (km)	Closest 100-m wind speed from technical potential (m/s)
61	Chena Ridge	510.32	470.18	40.13	7.81
62	Chenega Bay	27.25	0.00	27.25	7.06
64	Chickaloon	199.51	124.44	75.07	7.68
65	Chicken	452.31	447.01	5.30	8.47
66	Chignik	20.99	12.04	8.95	9.44
67	Chignik Lagoon	28.74	20.10	8.64	8.87
68	Chignik Lake	32.84	22.98	9.86	9.39
69	Chiniak	9.40	0.00	9.40	8.95
70	Chisana	229.06	223.41	5.65	8.23
71	Chistochina	262.29	236.66	25.63	7.9
72	Chitina	153.19	139.67	13.53	7.72
73	Chuathbaluk	249.25	244.26	4.99	8.13
74	Circle	623.43	597.21	26.22	7.9
75	Clam Gulch	28.19	0.83	27.37	7.26
76	Clark's Point	39.60	7.61	32.00	8.84
77	Coffman Cove	70.70	30.18	40.52	8.04
78	Cohoe	39.63	4.85	34.78	7.6
79	Cold Bay	24.38	11.15	13.23	9.35
81	College	515.03	477.05	37.98	7.81
83	Cooper Landing	78.96	63.02	15.94	7.22
84	Copper Center	189.49	164.03	25.46	7.9
85	Cordova	28.29	10.61	17.69	7.9
86	Covenant Life	134.41	124.40	10.01	7.87
87	Craig	41.12	0.25	40.86	8.22
88	Crooked Creek	262.02	245.55	16.47	7.02
89	Crown Point	61.99	46.38	15.61	7.22
90	Deering	174.66	164.98	9.68	7.73
91	Delta Junction	416.66	382.16	34.49	7.81
92	Deltana	400.13	376.13	24.00	7.9
93	Diamond Ridge	26.55	8.56	18.00	7.31
94	Dillingham	58.92	39.72	19.20	8.84
96	Dot Lake	387.54	363.06	24.47	7.9
97	Dot Lake Village	386.68	361.53	25.15	7.9

ID	Community	Total Distance to Resource (km)	Land Distance (km)	Water distance (km)	Closest 100-m wind speed from technical potential (m/s)
98	Dry Creek	379.87	354.44	25.43	7.9
99	Eagle	535.97	530.43	5.54	8.33
100	Eagle Village	535.76	530.12	5.64	8.23
101	Edna Bay	23.17	6.01	17.16	8.04
102	Eek	42.66	30.17	12.48	8.13
103	Egegik	19.76	0.62	19.14	8.67
104	Eielson AFB	488.48	449.02	39.46	7.81
105	Ekwok	102.31	84.98	17.33	8.86
106	Elfin Cove	22.11	0.10	22.01	7.52
107	Elim	11.00	0.24	10.76	7.73
108	Emmonak	21.30	17.43	3.87	8.13
109	Ester	515.90	475.98	39.92	7.81
111	Eureka Roadhouse	190.47	146.84	43.62	7.81
113	Excursion Inlet	80.79	9.37	71.42	7.52
114	Fairbanks	512.20	474.86	37.33	7.81
116	False Pass	16.93	10.45	6.47	9.61
117	Farm Loop	196.34	174.42	21.92	7.22
119	Farmers Loop	519.54	481.70	37.84	7.81
120	Ferry	433.50	386.95	46.56	7.81
121	Fishhook	208.21	184.73	23.48	7.22
123	Flat	214.81	199.84	14.97	7.02
124	Fort Greely	406.36	375.80	30.56	7.81
126	Four Mile Road	503.72	461.80	41.92	7.81
127	Fox	524.65	485.80	38.85	7.81
129	Fox River	54.72	44.82	9.90	7.07
130	Fritz Creek	41.41	30.51	10.89	7.27
131	Funny River	72.96	38.88	34.09	7.6
132	Gakona	225.54	199.07	26.48	7.9
133	Galena	216.17	207.50	8.67	7.15
135	Game Creek	67.01	51.43	15.59	7.36
136	Gateway	189.08	165.09	23.99	7.22
138	Glacier View	193.47	146.40	47.07	7.81
139	Glennallen	202.46	178.95	23.51	7.9

ID	Community	Total Distance to Resource (km)	Land Distance (km)	Water distance (km)	Closest 100-m wind speed from technical potential (m/s)
141	Goldstream	525.31	485.73	39.59	7.81
142	Golovin	22.22	7.78	14.44	7.29
143	Goodnews Bay	19.64	0.87	18.77	8.41
144	Grayling	109.24	87.84	21.40	7.05
145	Gulkana	221.54	195.40	26.14	7.9
146	Gustavus	64.74	2.73	62.01	7.52
147	Haines	137.42	112.09	25.34	8.29
148	Halibut Cove	44.97	2.94	42.03	7.36
149	Happy Valley	10.48	0.52	9.96	7.07
150	Harding-Birch Lakes	454.19	423.14	31.05	7.81
151	Healy	423.13	377.48	45.65	7.81
152	Healy Lake	416.27	389.98	26.30	7.9
153	Hobart Bay	20.16	7.76	12.39	13.12
154	Hollis	69.92	40.44	29.48	8.2
155	Holy Cross	183.36	162.33	21.02	7.05
156	Homer	26.94	2.10	24.84	7.34
157	Hoonah	73.43	47.29	26.14	7.36
159	Hope	119.65	104.31	15.34	7.22
160	Houston	195.54	58.29	137.25	7.38
162	Huslia	279.01	269.99	9.02	7.15
163	Hydaburg	39.09	9.78	29.31	7.81
164	Hyder	140.43	115.11	25.32	7.34
165	Igiugig	131.52	100.54	30.98	10.06
166	Iliamna	83.19	68.92	14.28	9.29
167	Ivanof Bay	22.76	6.61	16.15	8.14
168	Juneau	114.60	81.26	33.34	13.12
170	Kachemak	33.43	14.70	18.73	7.31
171	Kake	21.29	0.27	21.02	7.06
173	Kalifornsky	43.44	0.15	43.29	7.6
175	Kaltag	124.23	112.02	12.20	7.08
176	Karluk	9.71	1.55	8.16	8.31
177	Kasaan	60.59	8.52	52.07	7.26
178	Kasigluk	111.49	100.19	11.30	8.47

ID	Community	Total Distance to Resource (km)	Land Distance (km)	Water distance (km)	Closest 100-m wind speed from technical potential (m/s)
179	Kasilof	39.58	6.56	33.02	7.6
180	Kenai	54.98	0.82	54.15	7.6
181	Kenny Lake	166.76	136.75	30.01	7.9
182	Ketchikan	29.80	15.31	14.49	7.26
183	Kiana	286.29	242.23	44.05	7.73
184	King Cove	11.20	6.36	4.84	8.96
185	King Salmon	78.84	60.01	18.83	8.82
186	Kipnuk	18.06	5.37	12.69	8.79
187	Kivalina	289.69	96.53	193.16	7.67
188	Klawock	47.04	0.26	46.77	7.66
189	Klukwan	137.83	119.73	18.10	7.87
190	Knik River	176.48	163.83	12.65	7.22
194	Kobuk	354.30	316.89	37.41	7.34
195	Kodiak	13.17	6.19	6.98	8.81
196	Kodiak Station	24.22	14.41	9.82	8.81
197	Kokhanok	70.10	60.69	9.41	9.29
198	Koliganek	145.76	129.20	16.56	8.86
199	Kongiganak	12.26	6.50	5.76	8.47
200	Kotlik	15.77	8.27	7.51	7.83
201	Kotzebue	265.30	168.67	96.63	7.73
202	Koyuk	67.29	12.54	54.75	7.34
203	Koyukuk	184.69	176.42	8.27	7.15
204	Kupreanof	65.56	31.67	33.90	7.61
205	Kwethluk	115.17	105.56	9.61	8.13
206	Kwigillingok	7.01	3.96	3.05	8.69
207	Lake Louise	221.28	179.96	41.32	7.81
208	Lake Minchumina	401.76	369.70	32.06	7.38
209	Lakes	192.89	169.43	23.45	7.22
214	Larsen Bay	26.55	21.17	5.39	8.2
215	Lazy Mountain	195.02	183.85	11.17	7.25
217	Levelock	99.64	50.15	49.49	8.89
218	Lime Village	208.36	201.78	6.58	7.48
219	Livengood	594.97	553.74	41.22	7.81

ID	Community	Total Distance to Resource (km)	Land Distance (km)	Water distance (km)	Closest 100-m wind speed from technical potential (m/s)
220	Loring	57.59	46.07	11.52	7.26
221	Lowell Point	28.29	7.63	20.66	7.22
222	Lower Kalskag	210.38	203.86	6.52	8.13
223	Lutak	142.78	121.54	21.24	8.29
224	Manley Hot Springs	515.76	506.82	8.94	7.15
225	Manokotak	37.45	30.39	7.06	8.56
226	Marshall	148.27	141.29	6.98	7.46
227	McCarthy	155.63	150.33	5.30	8.47
228	McGrath	287.57	273.94	13.63	7.03
229	McKinley Park	409.32	362.05	47.27	7.81
230	Meadow Lakes	196.61	164.58	32.03	7.22
234	Mendeltna	196.79	160.40	36.39	7.81
235	Mentasta Lake	313.77	300.47	13.30	7.72
236	Mertarvik	32.84	25.36	7.49	7.93
237	Metlakatla	16.82	2.47	14.35	7.3
238	Minto	561.39	511.20	50.18	7.38
239	Moose Creek	494.14	452.70	41.44	7.81
240	Moose Pass	69.13	52.71	16.42	7.22
241	Mosquito Lake	141.74	91.52	50.22	7.03
242	Mountain Village	88.38	79.85	8.54	8.15
243	Mud Bay	134.57	95.80	38.77	8.29
244	Nabesna	260.67	255.37	5.30	8.47
245	Naknek	65.64	31.42	34.22	8.82
246	Nanwalek	8.07	0.20	7.87	7.44
247	Napakiak	95.14	63.22	31.92	8.52
248	Napaskiak	99.03	87.55	11.48	8.13
249	Naukati Bay	44.74	13.22	31.52	8.04
250	Nelchina	190.99	151.32	39.68	7.81
251	Nelson Lagoon	6.76	0.23	6.54	8.92
252	Nenana	499.19	457.27	41.92	7.81
254	New Stuyahok	116.52	98.35	18.16	8.86
255	Newhalen	81.06	67.81	13.25	9.29
256	Newtok	28.18	18.93	9.25	8.01

ID	Community	Total Distance to Resource (km)	Land Distance (km)	Water distance (km)	Closest 100-m wind speed from technical potential (m/s)
257	Nightmute	22.29	21.21	1.08	8
258	Nikiski	64.82	5.67	59.16	7.38
259	Nikolaevsk	22.91	12.39	10.52	7.25
260	Nikolai	324.14	315.71	8.43	7.48
262	Ninilchik	10.51	0.13	10.38	7.11
263	Noatak	309.59	202.25	107.34	7.67
265	Nondalton	91.78	78.75	13.03	9.29
266	Noorvik	264.46	221.49	42.97	7.73
267	North Pole	499.93	458.24	41.70	7.81
268	Northway	328.95	323.64	5.31	8.47
269	Northway Junction	334.58	328.93	5.65	8.23
270	Northway Village	331.13	325.82	5.31	8.47
272	Nulato	161.21	152.76	8.45	7.15
273	Nunam Iqua	12.15	3.09	9.06	8.15
274	Nunapitchuk	111.80	93.50	18.31	8.47
275	Old Harbor	22.57	14.23	8.34	8.38
276	Oscarville	100.59	89.08	11.51	8.13
277	Ouzinkie	14.32	5.44	8.88	8.9
278	Palmer	191.95	169.92	22.03	7.22
279	Paxson	311.36	279.50	31.86	7.87
280	Pedro Bay	46.67	39.09	7.58	9.08
281	Pelican	25.26	12.65	12.61	7.72
282	Perryville	12.30	0.93	11.37	7.57
283	Petersburg	67.13	32.20	34.93	7.61
284	Petersville	257.44	202.66	54.78	7.38
285	Pilot Point	18.71	0.32	18.39	8.41
286	Pilot Station	131.43	124.96	6.48	7.55
287	Pitkas Point	110.07	100.23	9.84	8.15
288	Platinum	2.31	0.92	1.39	8.41
289	Pleasant Valley	511.86	478.52	33.34	7.81
290	Point Baker	51.66	11.41	40.24	7.02
293	Point Mackenzie	167.63	33.57	134.06	7.38
294	Point Possession	106.15	51.85	54.30	7.74

ID	Community	Total Distance to Resource (km)	Land Distance (km)	Water distance (km)	Closest 100-m wind speed from technical potential (m/s)
295	Pope-Vannoy Landing	54.47	43.88	10.59	9.29
296	Port Alexander	7.98	1.65	6.33	7.88
297	Port Alsworth	89.86	76.40	13.45	9.08
299	Port Graham	12.34	0.13	12.21	7.44
300	Port Heiden	14.14	4.02	10.12	8.5
301	Port Lions	35.13	2.47	32.66	8.61
302	Port Protection	54.47	11.77	42.70	7.02
304	Primrose	53.16	37.87	15.29	7.22
306	Quinhagak	5.90	0.22	5.68	7.98
307	Rampart	543.81	535.26	8.56	7.15
308	Red Devil	296.73	281.02	15.71	7.02
309	Red Dog Mine	357.72	210.05	147.67	7.67
310	Ridgeway	60.09	14.19	45.90	7.6
312	Ruby	284.06	275.19	8.87	7.15
313	Russian Mission	175.32	168.11	7.21	7.46
314	Salamatof	57.64	1.87	55.77	7.74
315	Salcha	472.29	437.68	34.61	7.81
316	Sand Point	6.99	1.30	5.69	8.4
318	Saxman	28.99	7.91	21.08	7.26
320	Selawik	254.71	229.59	25.12	7.73
321	Seldovia	17.14	4.34	12.79	7.39
322	Seldovia Village	20.62	0.45	20.17	7.38
323	Seward	31.06	9.94	21.12	7.22
324	Shageluk	144.44	126.51	17.93	7.04
325	Shaktolik	8.68	0.26	8.43	7.15
327	Shungnak	345.78	305.65	40.13	7.34
328	Silver Springs	193.90	167.95	25.95	7.9
329	Sitka	19.84	1.35	18.49	7.12
330	Skagway	161.84	139.69	22.15	8.29
331	Skwentna	194.34	147.77	46.57	7.38
332	Slana	287.98	267.25	20.73	8.16
333	Sleetmute	306.56	290.88	15.68	7.02
334	Soldotna	58.29	15.88	42.41	7.6

ID	Community	Total Distance to Resource (km)	Land Distance (km)	Water distance (km)	Closest 100-m wind speed from technical potential (m/s)
335	South Naknek	65.29	38.08	27.21	8.82
336	South Van Horn	509.63	471.63	38.00	7.81
338	St. Mary's	114.01	105.38	8.63	8.15
339	St. Michael	9.61	1.10	8.51	7.28
341	Stebbins	9.51	3.05	6.46	7.55
342	Steele Creek	519.94	478.21	41.73	7.81
345	Sterling	74.80	39.72	35.08	7.6
347	Stony River	285.62	278.99	6.63	7.48
348	Sunrise	113.89	97.00	16.89	7.22
349	Susitna	165.65	46.29	119.36	7.38
351	Susitna North	244.98	129.23	115.75	7.38
352	Sutton-Alpine	208.78	127.99	80.79	7.68
353	Takotna	264.30	250.59	13.71	7.03
354	Talkeetna	252.07	164.68	87.39	7.38
355	Tanacross	368.80	355.45	13.36	7.72
356	Tanaina	195.79	171.37	24.42	7.22
358	Tanana	450.19	441.51	8.68	7.15
359	Tatitlek	69.16	22.03	47.13	7.81
360	Tazlina	197.68	171.36	26.31	7.9
362	Tenakee Springs	64.78	41.24	23.54	7.18
363	Tetlin	345.76	340.48	5.28	8.47
364	Thorne Bay	78.57	27.40	51.17	7.26
365	Togiak	16.45	1.23	15.22	8.09
366	Tok	367.88	354.79	13.09	7.72
368	Tolsona	197.89	164.64	33.25	7.81
370	Tonsina	156.36	130.50	25.86	7.9
371	Trapper Creek	248.60	163.63	84.97	7.38
372	Tuluksak	154.97	147.90	7.06	8.13
373	Tuntutuliak	49.80	43.56	6.24	8.47
375	Twin Hills	21.31	4.47	16.84	8.09
376	Two Rivers	511.58	474.22	37.37	7.81
377	Tyonek	102.88	2.51	100.37	7.38
378	Ugashik	30.69	12.07	18.62	8.41

ID	Community	Total Distance to Resource (km)	Land Distance (km)	Water distance (km)	Closest 100-m wind speed from technical potential (m/s)
379	Unalakleet	12.38	0.30	12.08	7.08
382	Valdez	92.29	51.84	40.44	7.81
386	Wasilla	190.78	166.32	24.46	7.22
387	Whale Pass	60.29	15.37	44.92	8.04
388	White Mountain	23.35	15.82	7.53	7.2
389	Whitestone	429.18	395.03	34.15	7.81
390	Whitestone Logging Camp	71.77	56.14	15.63	7.36
391	Whittier	99.93	86.02	13.91	7.38
392	Willow	198.61	67.21	131.40	7.38
393	Willow Creek	173.58	148.33	25.26	7.9
396	Womens Bay	32.81	24.25	8.56	8.81
397	Wrangell	118.77	70.83	47.95	7.61
398	Yakutat	14.16	6.07	8.09	7.23



U.S. Department of the Interior (DOI)

DOI protects and manages the Nation's natural resources and cultural heritage; provides scientific and other information about those resources; and honors the Nation's trust responsibilities or special commitments to American Indians, Alaska Natives, and affiliated island communities.



Bureau of Ocean Energy Management (BOEM)

BOEM's mission is to manage development of U.S. Outer Continental Shelf energy and mineral resources in an environmentally and economically responsible way.

BOEM Environmental Studies Program

The mission of the Environmental Studies Program is to provide the information needed to predict, assess, and manage impacts from offshore energy and marine mineral exploration, development, and production activities on human, marine, and coastal environments. The proposal, selection, research, review, collaboration, production, and dissemination of each of BOEM's Environmental Studies follows the DOI Code of Scientific and Scholarly Conduct, in support of a culture of scientific and professional integrity, as set out in the DOI Departmental Manual (305 DM 3).